

METER

ultrasonic level transmitter

www.merecom.cz

MERECOM s.r.o. tel.: (+420) 537 021 333, mobil: (+420) 774 434 484, e-mail: info@merecom.cz

CONTENTS

1-WARRANTY	pag. 3
2-PRODUCT	pag. 4
3-PERFORMANCE SPECIFICATIONS	pag. 5
4-DIMENSIONS	pag. 6
5-INSTALLATION	pag. 7
6-ELECTRICAL CONNECTIONS	pag. 11
7-LOCAL OPERATOR INTERFACE (LOI)-VL601	pag. 13
8-QUICK SETUP	pag. 15
9-ADVANCED SETUP	pag. 23
10-FACTORY TEST AND QUALITY CERTIFICATE	pag. 40

1-WARRANTY

Products supplied by SGM LEKTRA are guaranteed for a period of 12 (twelve) months from delivery date according to the conditions specified in our sale conditions document.

SGM LEKTRA can choose to repair or replace the Product.

If the Product is repaired it will maintain the original term of guarantee, whereas if the Product is replaced it will have 12 (twelve) months of guarantee.

The warranty will be null if the Client modifies, repair or uses the Products for other purposes than the normal conditions foreseen by instructions or Contract.

In no circumstances shall SGM LEKTRA be liable for direct, indirect or consequential or other loss or damage whether caused by negligence on the part of the company or its employees or otherwise howsoever arising out of defective goods

2- PRODUCT

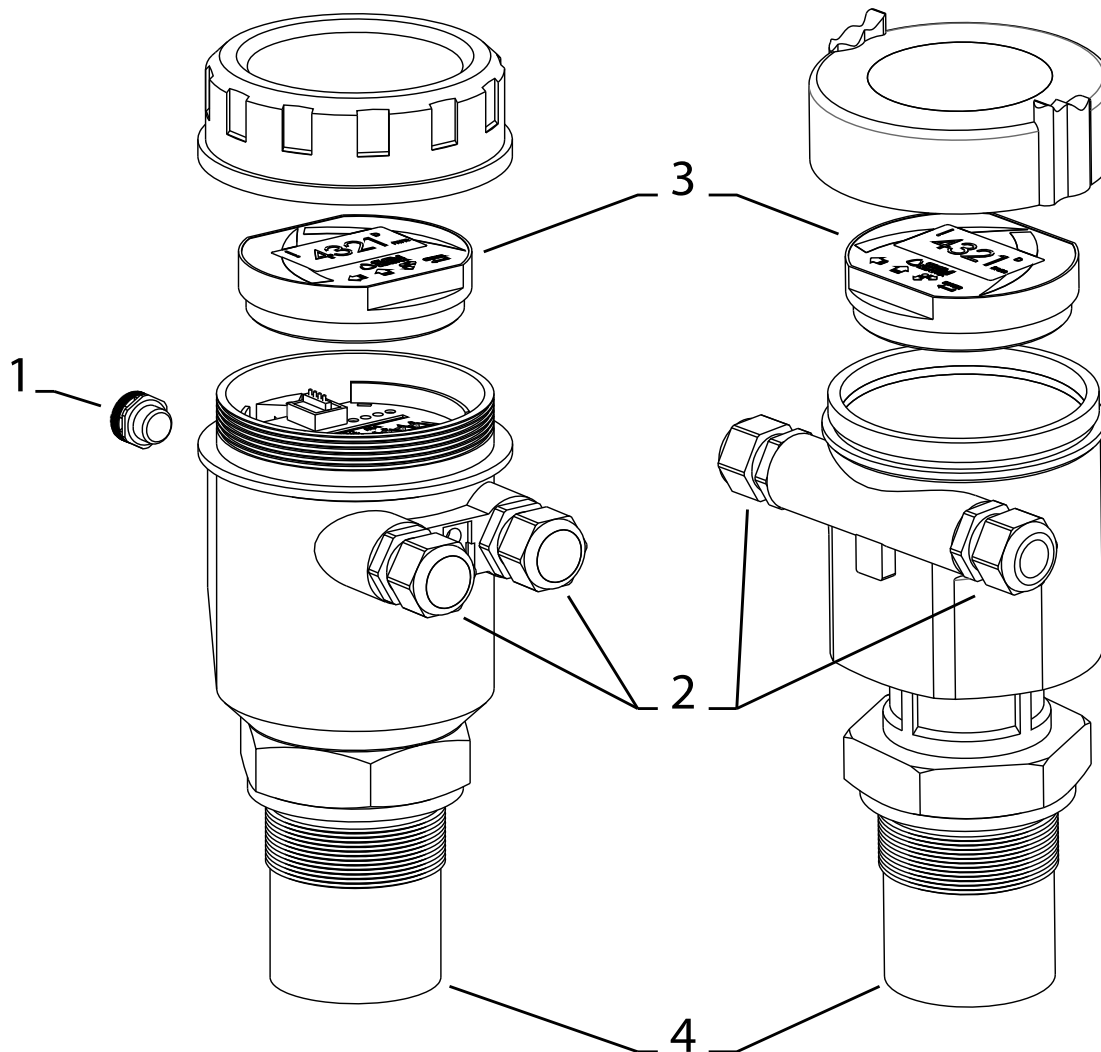

1. Anticondensation filter
2. M20 skintop
3. VL601 (opt.)
4. Sensor

2.1 IDENTIFICATION

Each meter has an adhesive identification plate on which are the meter main data. The following picture describes the information and data on the identification plate.

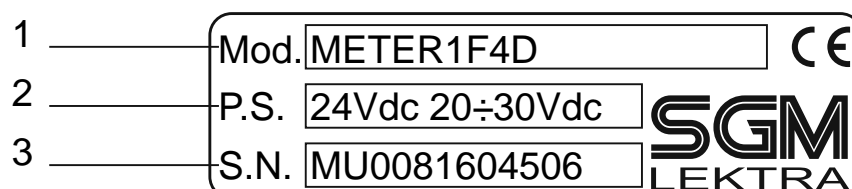

1. Product code

2. Power supply

3. Serial number

3-FEATURES

Housing/sensor material

PC or Al / PP wetted part (only PVDF for ATEX certified vers.)

Mechanical installation

2" GAS M (PP flange DN80 opt.)

Protection degree

IP67/IP68 (Sensor)

Electrical connection

Internal push connectors

Working temperature

-30 ÷ +70°C; +80°C non-continuous

Pressure

from 0,5 to 1,5 bar (absolute)

Power supply

12Vdc / 20÷30Vdc (2-wires versions) - 24Vdc (4-wires versions)

Power consumption

0,6W (2-wires) - 1,5W (4-wires)

Analog output

4...20mA, max 750ohm (4-wires versions)

Relays output

(4-wire only) n°2 3A 230Vac (n.o.)

Digital communication

MODBUS RTU for 4-wire vers. ; (opt.) HART for 2-wire vers.

Max measure range

max 0.25 ÷ 6m

max 0.40 ÷ 10m

In case of non perfectly reflecting surfaces, the maximum distance value will be reduced

Blind distance

0,25m (6m versions) / 0,40m (10m versions)

Temperature compensation

digital from -30 to 80°C

Accuracy

±0,2% (of the measured distance) not better than ±3mm.

Resolution

1mm.

Calibration

4 buttons or via HART / MODBUS RTU

Warm-up

5 minutes typical

LCD Display

Plug-in display/keyboard 4 buttons matrix LCD

Ex-proof

ATEX II 1/2G Ex ia II C T6 Tamb -20 ÷ +60°C

4-DIMENSIONS

4.1 MECHANICAL DIMENSIONS

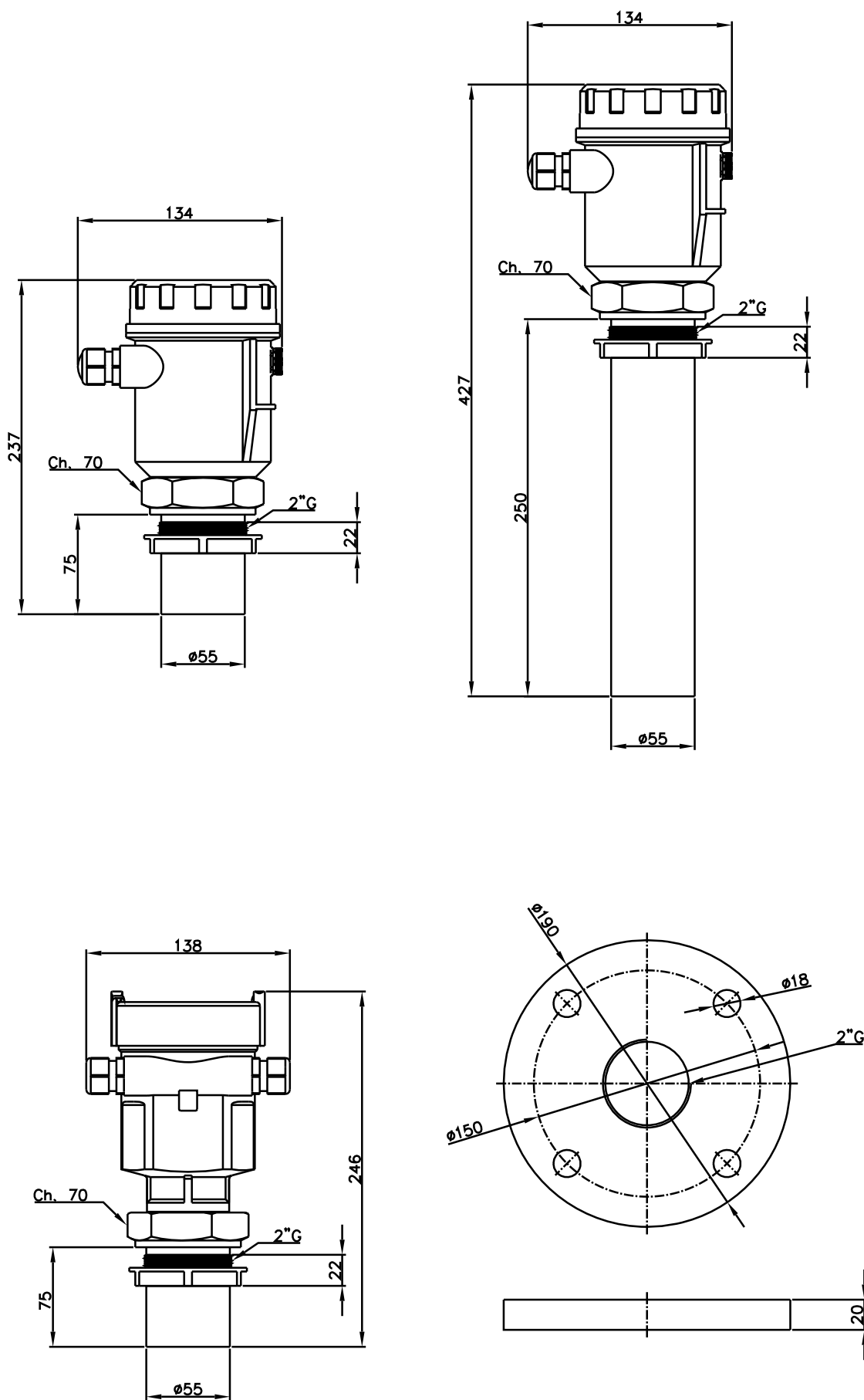

5-INSTALLATION

5.1 MOUNTING PRECAUTIONS

5.1.1 Mounting position

- With cambered roof, Do not install the sensor in the tank center (b). Leave a 300mm (d) minimum distance between the sensor and the tank smooth wall.
- Use a protective cover to protect the sensor from weather and direct sunlight (c).
- Do not install the sensor near the load zone (a).
- Make sure that in the sensor emission beam (lobe "α") there are no obstacles (f,s) that can be intercepted as level.
- Make sure that there is not foam presence on the product surface to be measured.

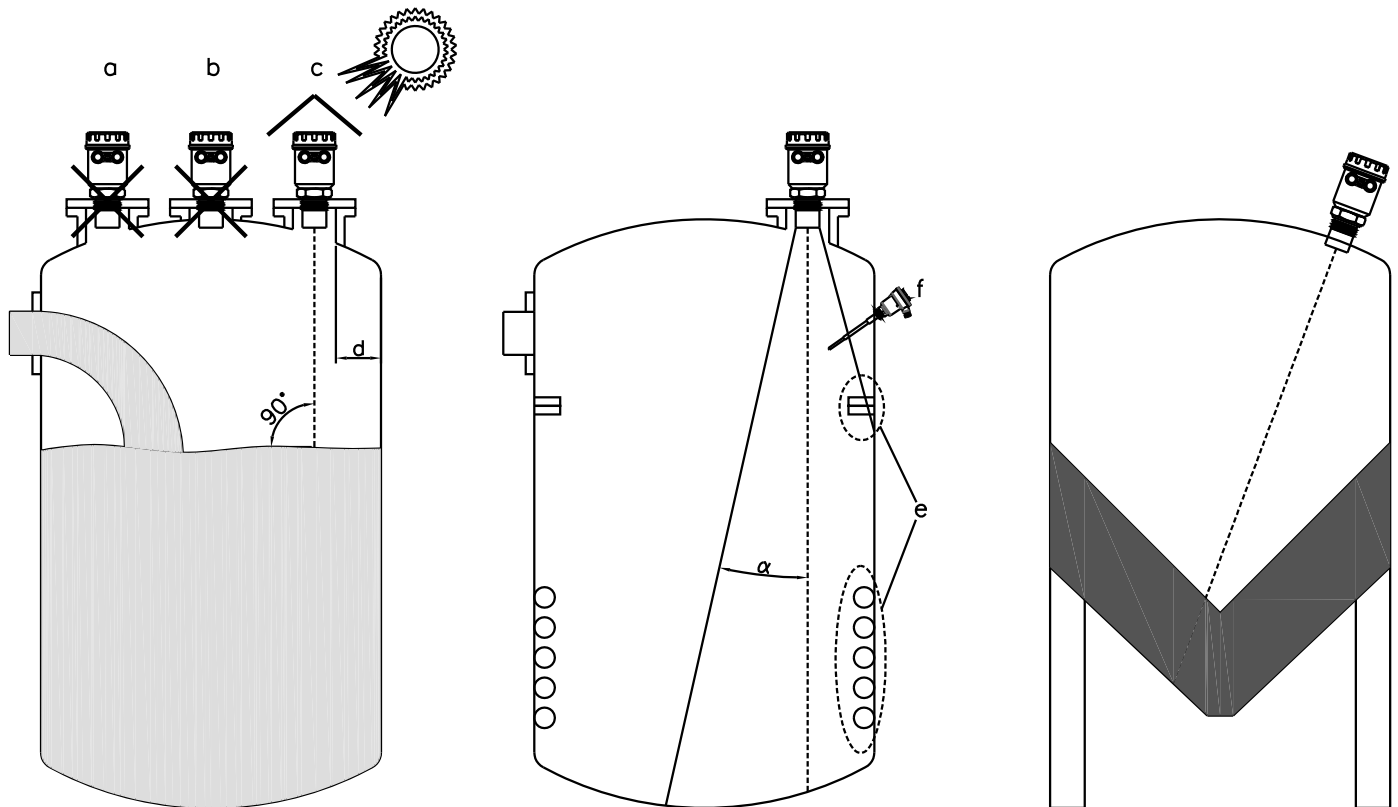

	Lobo "α"
METER 6mt	5°
METER 10mt	5°

5.1.2 Blind distance

During installation is important to remember that in the sensor vicinity there is a blind zone (or BLIND DISTANCE) of 0.25m (for 6m max METER range) or 0.4m (for 10m max METER range) where the sensor can not measure.

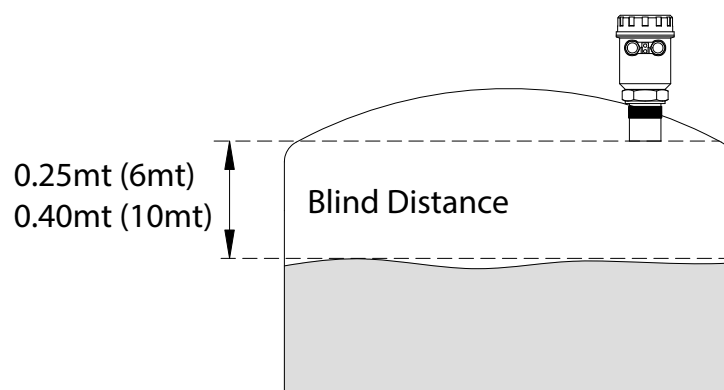

5.1.3 Installation in nozzle

Installing the METER sensor in a nozzle, make sure the sensor bottom protrudes at least 10 mm from the bottom nozzle.

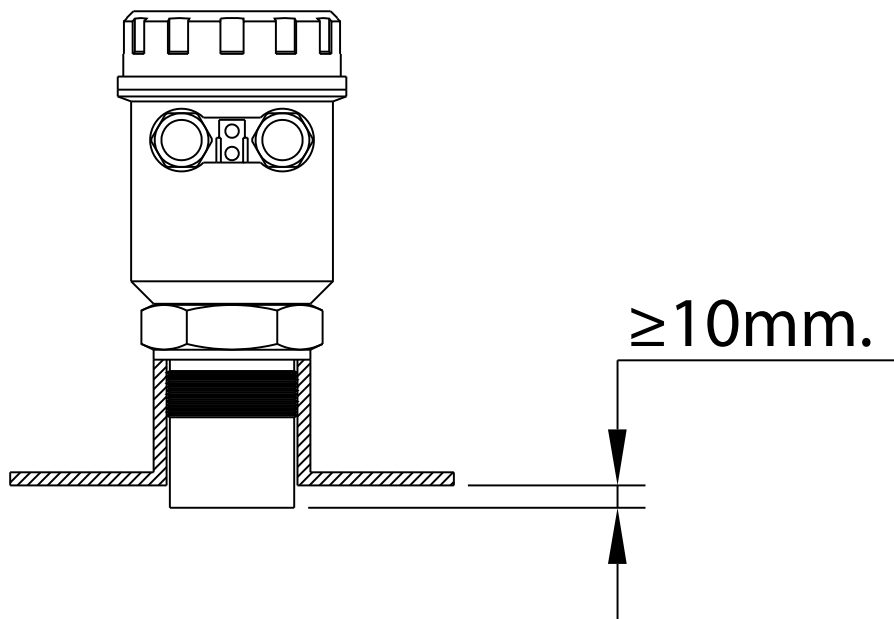

METER can be installed in an extension pipe to turn away the sensor from the maximum level point. The extension pipe must be flat and without joints (welds, etc..), also, the pipe terminal part must be cut at 45° and with the borders without burr.

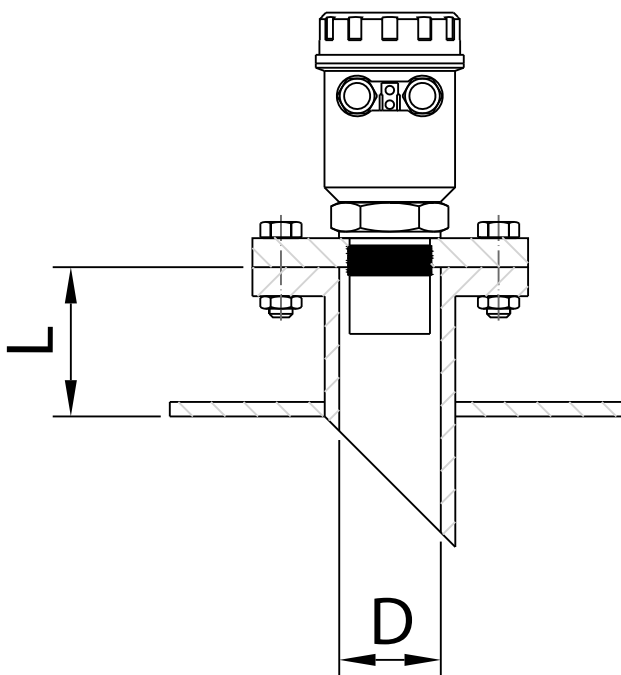

METER 6mt		METER 10mt	
D (mm)	Lmax(mm)	D (mm)	Lmax(mm)
57	180	80	240
80	240	100	300
100	300		

5.1.4 Reference pipe installation

Disturbing factors that may influence the level measurement in liquids, as for example:

- foam presence on the product surface
- internal structures presence in the tank
- presence on the liquid surface of floating bodies

can be avoided with the use of level measurement inside of pipes (by-pass pipe or calm pipe with 57mm min. diameter). The pipe must have a length greater or equal than the empty distance, also, must have some of vent holes to allow the pipe regular filling and emptying.

In the programming menu, to the "PRODUCT" parameter, must select the "LIQUID PIPE" option

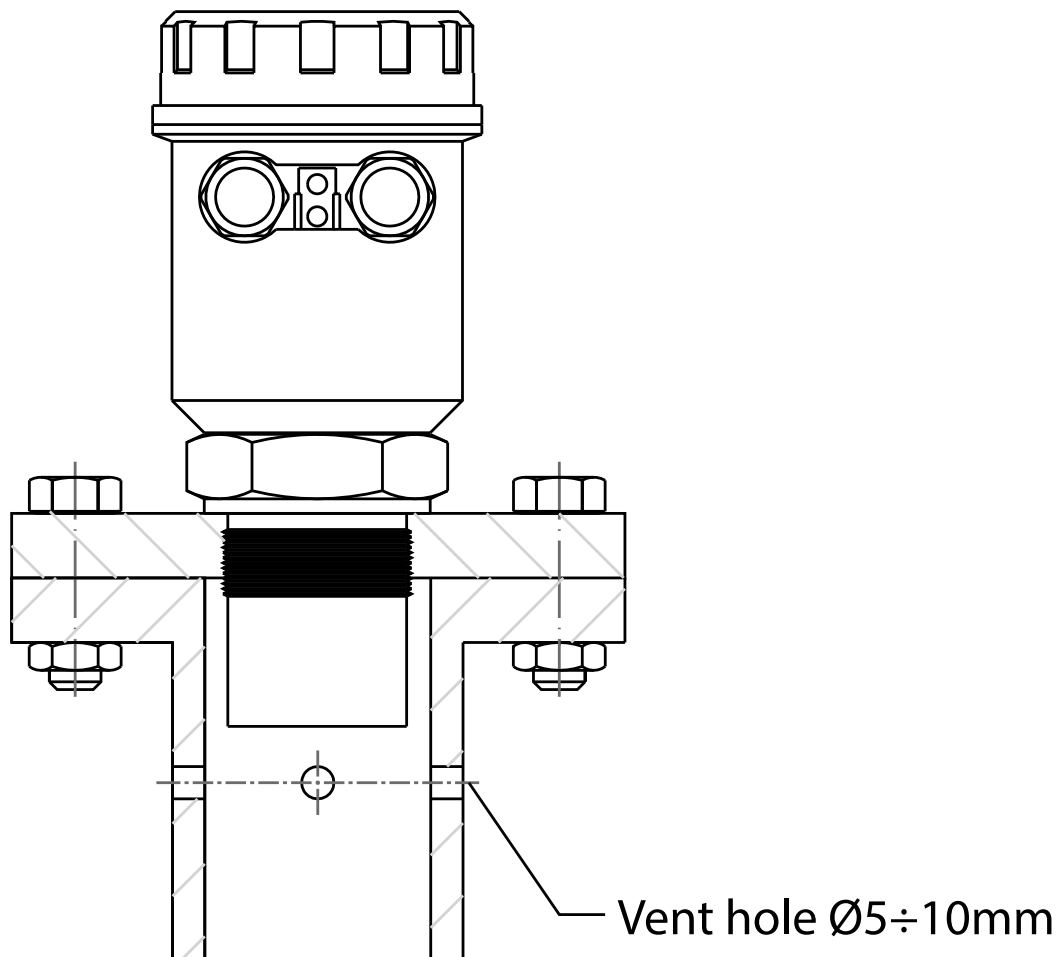
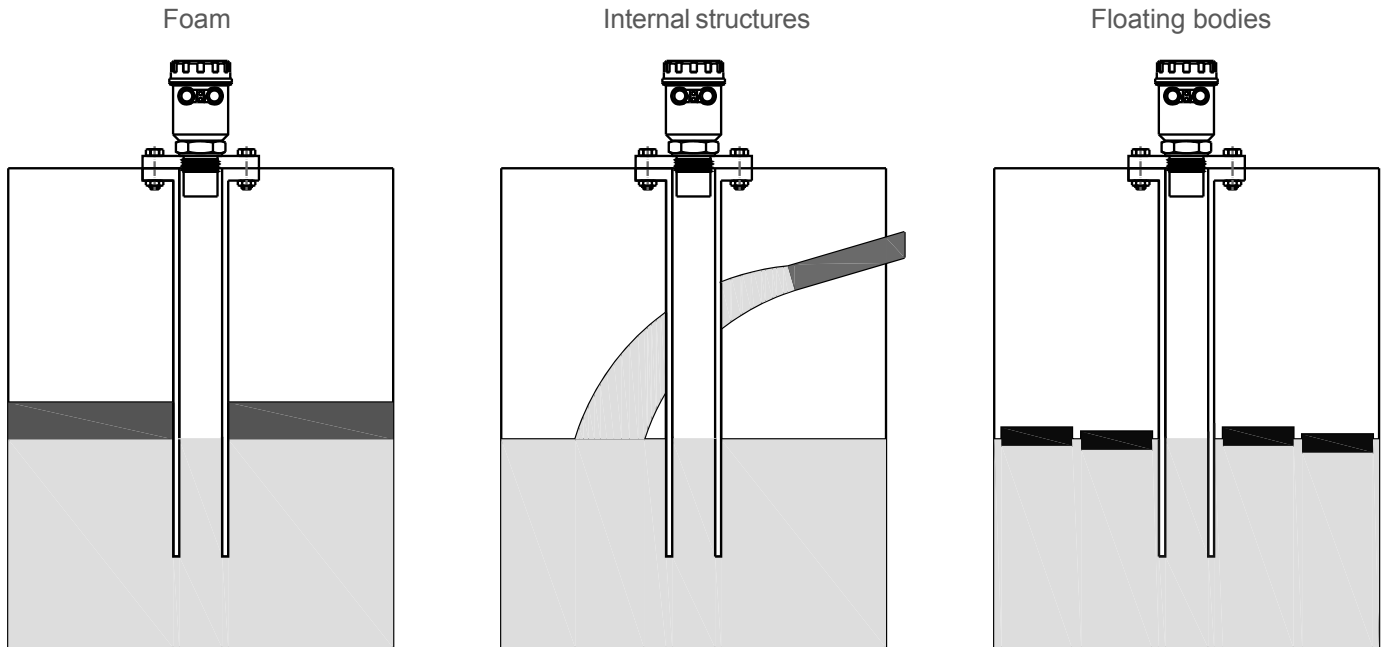

5.1.5 Agitators presence

The level measurement is possible thanks to the Auto-Tuned statistical filter.

Should rarely need to adjust the filter setting by editing 2 METER sensor programming parameters:

- FILTER; this parameter is present in the Quick Setup menu and in the Advanced Configuration "SETUP" menu; increasing the parameter value, decreases the sensor sensitivity to the level measurement sudden variations.
- F-WINDOW; this parameter is present in the Advanced Configuration "SERVICE" menu; decreasing the parameter programmed value, increases the sensor immunity to false echoes.

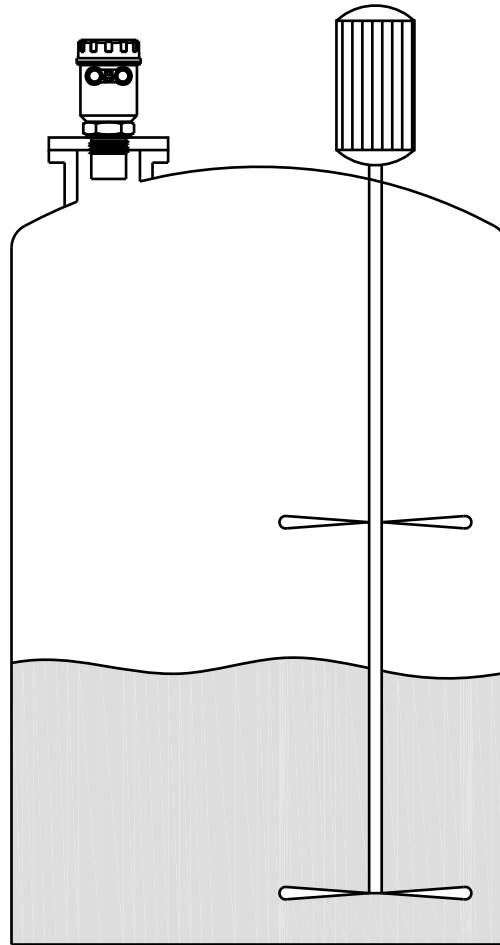

6-ELECTRICAL CONNECTIONS

6.1 WIRING

- 1) Separate the engine control cables or power cables from the METER connection cables
- 2) Open the cap by unscrewing.
- 3) Lead the cables into the transmitter through the glands
- 4) Do not use sleeves terminals, because they might interfere with the VL601 module insertion
- 5) Close the cap and tighten the cable glands

2 - WIRE VERSION

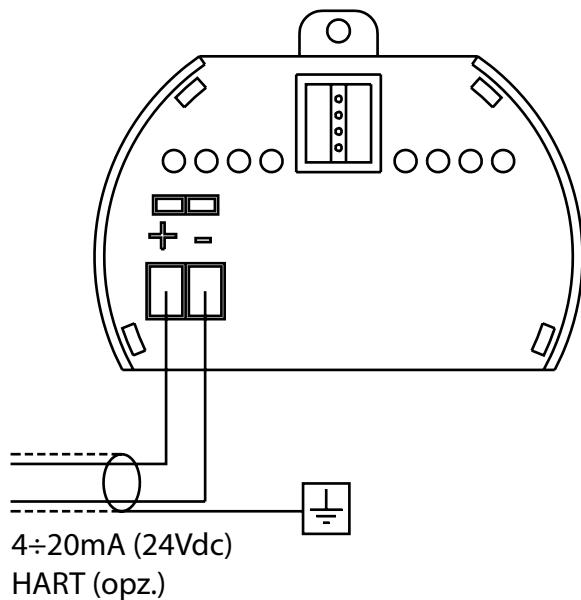

4 - WIRE VERSION

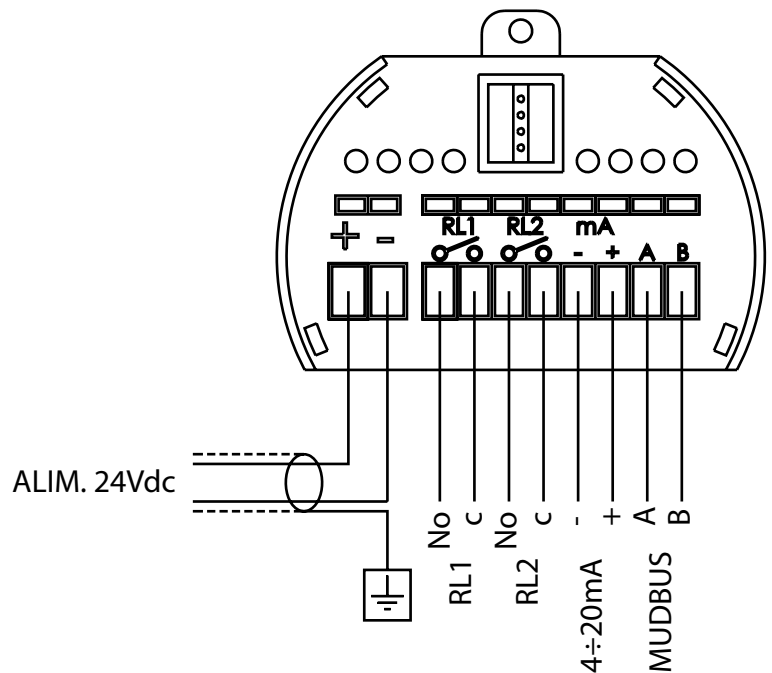

6.2 HUMIDITY INFILTRATIONS

To avoid the humidity infiltration inside the housing is recommended:

- for electrical connections, use a cable with a 6÷12mm outer diameter and fully tighten the M20 cable gland
- fully tighten the cap
- position the cable so that it forms a downward curve at the M20 output; in this way the condensation and/or rain water will tend to drip from the curve bottom

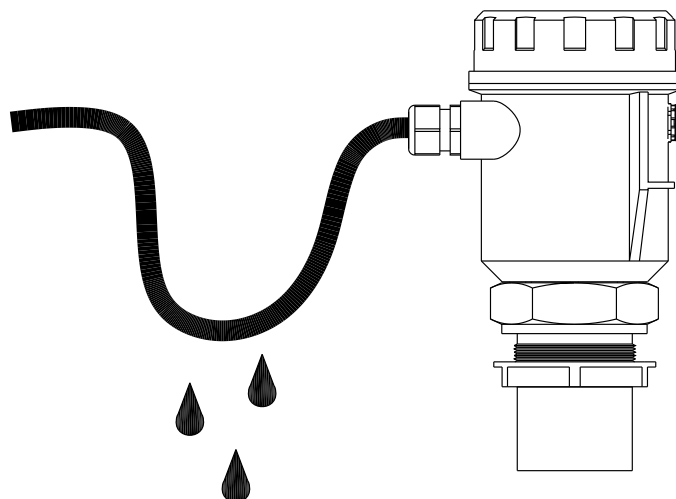

6.3 DIGITAL COMMUNICATIONS CONNECTION

6.3.1 - 4-wires METER; MODBUS RTU PC connection

- 1) METER4___ or METER8___ with MODBUS RTU communication protocol
- 2) USB/RS485 interface module, cod.694A004A
- 3) MODBUS RTU communication S/W, cod.010F105A, for METER transmitter

With this software is possible:

- connect, by selecting the UID address, the METER transmitters in MODBUS RTU network
- read on your PC monitor all measures in reading and METER operation data
- programming all METER configuration parameters
- storing on files, data logger function; METER measures in reading and operating states

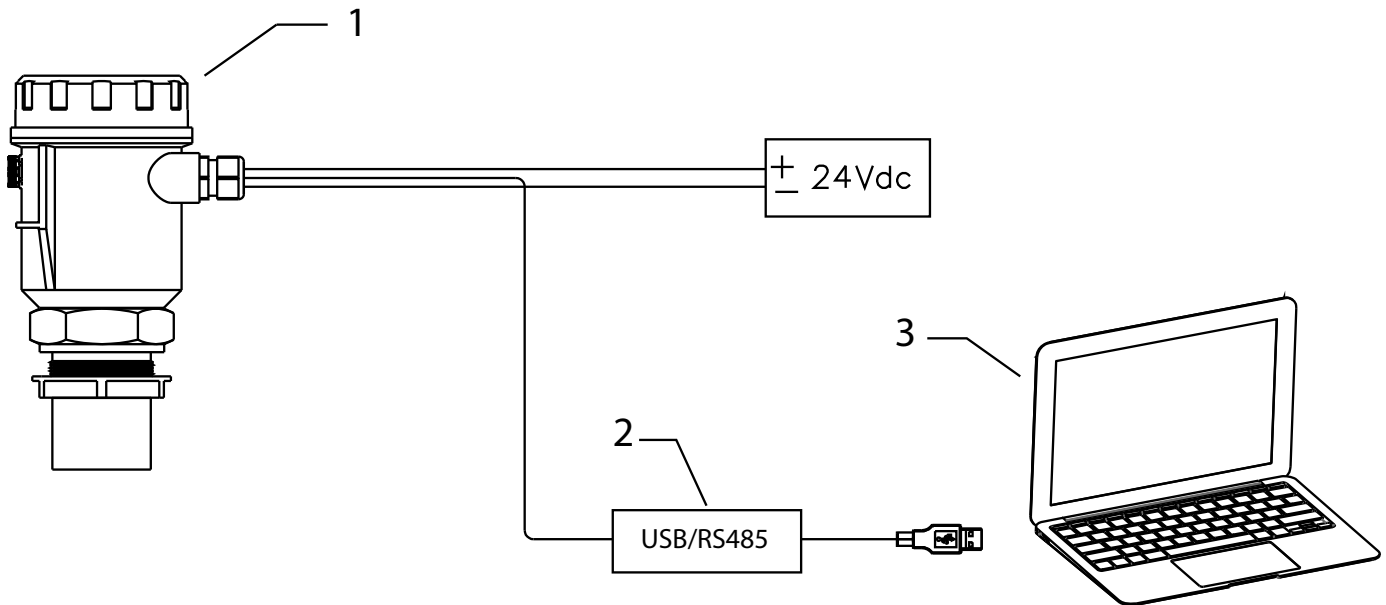

6.3.2 - 2-wires METER; HART Hand Held connection or HART PC/MODEM

- 1) METER-___, METER0___, METER2___, METER7___, with HART communication protocol
- 2) 250ohm resistance
- 3) HART MODEM
- 4) HART communication S/W, cod.010E105A (for PC HART MODEM only)
- 5) HART HAND-HELD

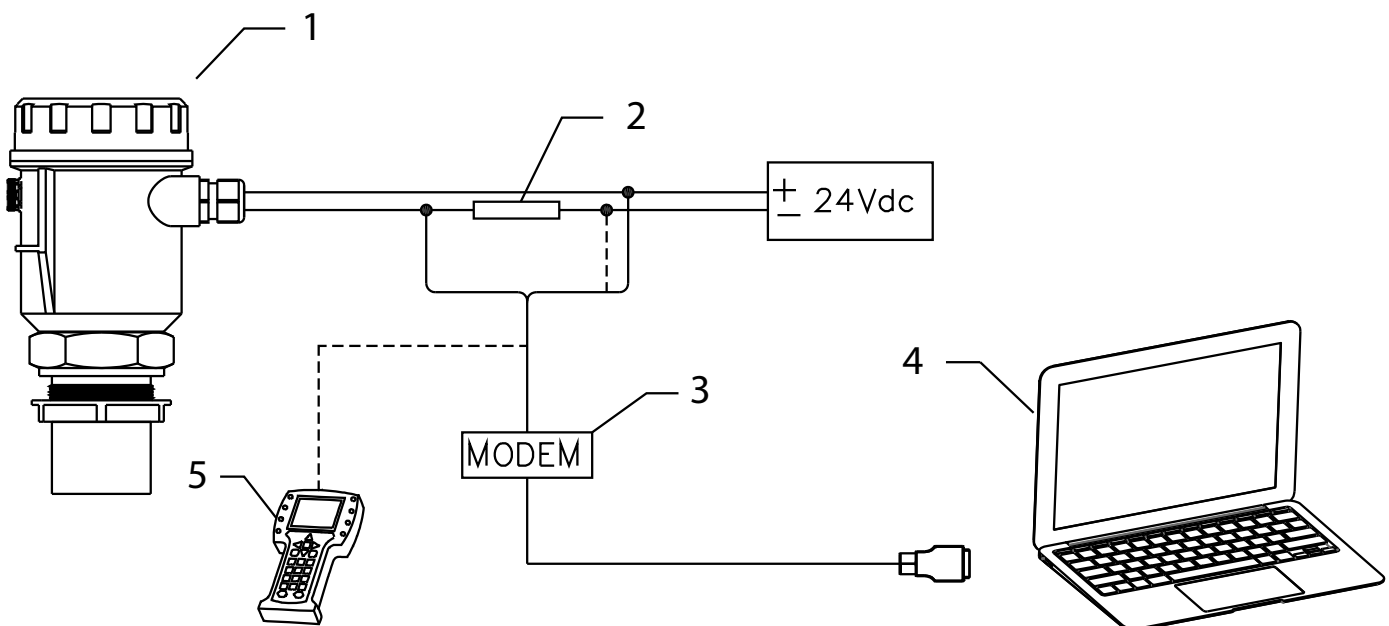









7-LOCAL OPERATOR INTERFACE (LOI) - VL601

LOI is an operator communications center for the METER. Through the LOI, the operator can access any transmitter function for changing configuration parameter settings or other functions.





7.1 VL601 FEATURES

The VL601 program module has 4 buttons which allow to perform all operational, control and programming instrument functions.

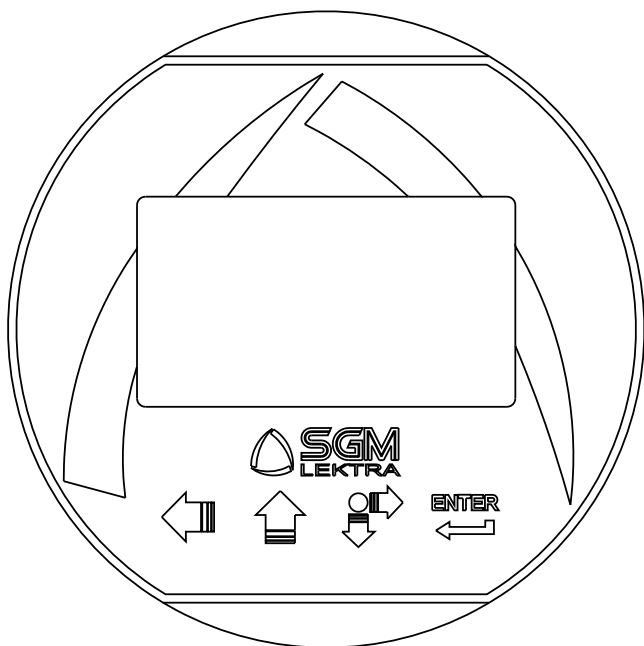
In the configuration menus, is possible:

1. Submenus and parameters access; press  to select and press  to access.
2. Parameter options choice: Press  to select the option and press  to store the option.
Press  to exit without storing.
3. Configure the parameter values; in some parameters the configuration is done by setting a value (eg., in the SET DISTANCE 4mA parameter is possible to change the the corresponding distance value, in mm):
press  to select the digit to be modified (the digit is highlighted in inverse), press  to change the high lighted digits number, press  to save the set value and exit automatically.
Press  to exit without storing.



-  LEFT ARROW button:
 - Exit configuration
 - Back to previous menu
 - Echo map (from RUN mode)
-  UP ARROW button:
 - Parameter values modification
 - Parameter scroll
-  SCROLL button:
 - Cursor movement (to the right)
 - Parameter scroll
-  ENTER button:
 - Configuration access
 - Options confirmation
 - Parameters values confirmation

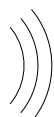

Displayed at the bottom indicates the correct echo signal reception



Displayed at the top alerts that there is a generic error; press SCROLL to show the message that indicates the present error type.

- The METER returns automatically to RUN mode.

The VL601 programming module can be mounted and removed from the METER without affecting the unit operation. Unscrewing the cap, the VL601 module can be mounted (by clockwise rotation until it clicks) or dismantled (by rotation counterclockwise) as shown in figure.

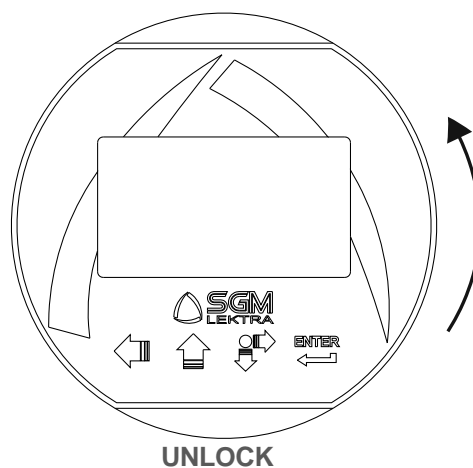
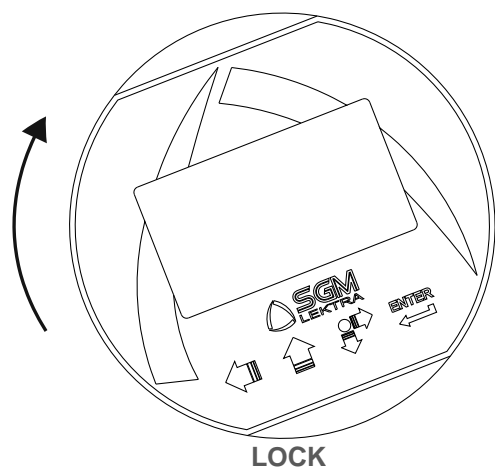

8-QUICK SETUP

8.1 - Quick Setup menu structure

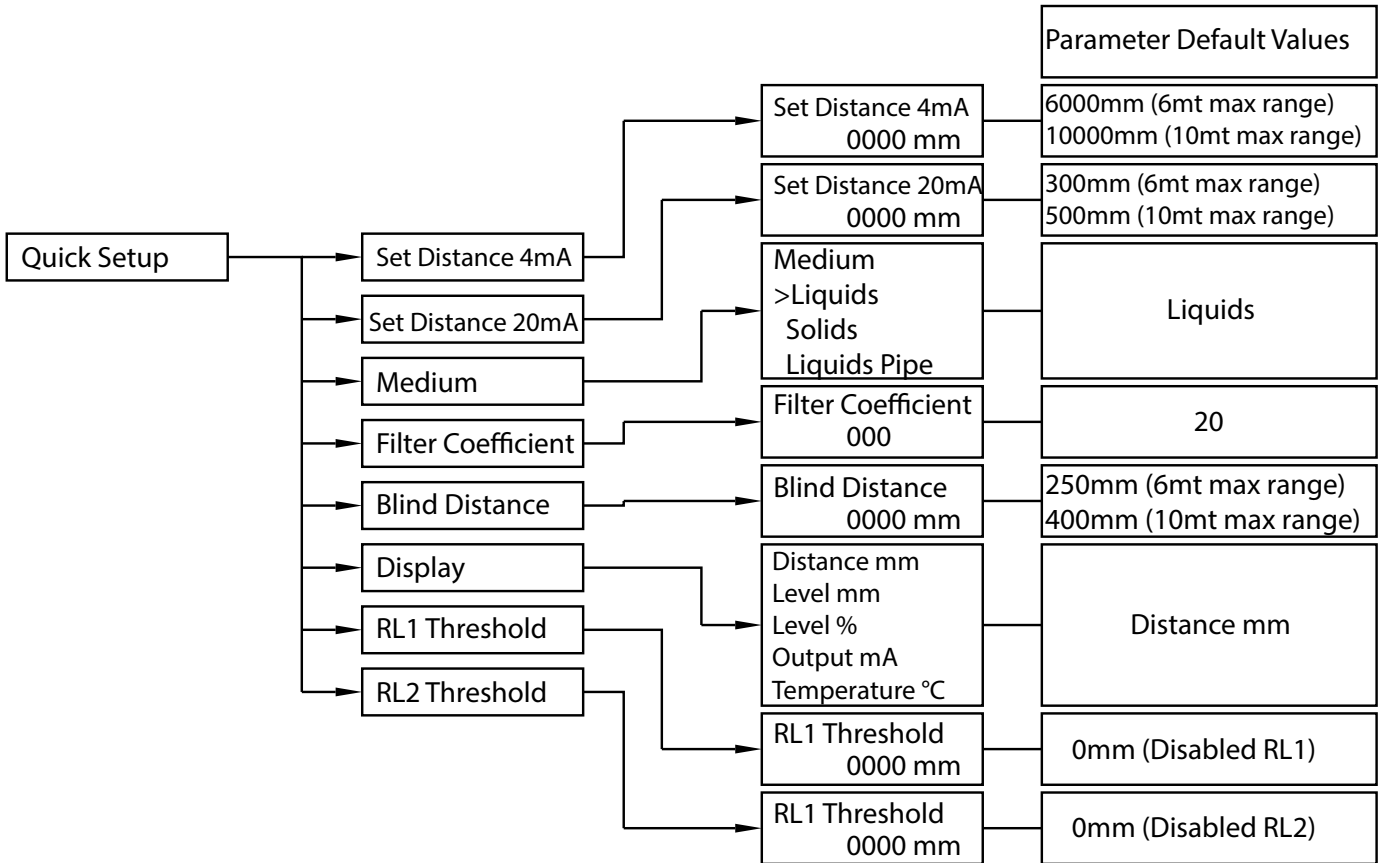

8.2 - QUICK SETUP MODE

From "RUN" mode press ENTER to access the Quick Setup menu.

Select the parameters by moving the cursor with SCROLL, and confirm with ENTER; press LEFT ARROW to exit.

4321^D mm

► SET DISTANCE 4mA
 SET DISTANCE 20mA
 MEDIUM
 FILTER COEFFICIENT
 BLIND DISTANCE
 DISPLAY
 RL1 THRESHOLD
 RL2 THRESHOLD

8.2.1 SET DISTANCE 4mA

Press ENTER to display the distance value associated with 4mA output.

Use SCROLL and UP ARROW to modify that value; in the example the 4mA distance is 3500mm.
Press ENTER to confirm.

```

▶ SET DISTANCE 4mA
  SET DISTANCE 20mA
  MEDIUM
  FILTER COEFFICIENT
  BLIND DISTANCE
  DISPLAY
  RL1 THRESHOLD
  RL2 THRESHOLD
    
```

```

SET DISTANCE 4mA

3500 mm
    
```

8.2.2 SET DISTANCE 20mA

Press ENTER to display the distance value associated with 20mA output.

Use SCROLL and UP ARROW to modify that value; in the example the 20mA distance is 500mm.
Press ENTER to confirm.

```

SET DISTANCE 4mA
▶ SET DISTANCE 20mA
  MEDIUM
  FILTER COEFFICIENT
  BLIND DISTANCE
  DISPLAY
  RL1 THRESHOLD
  RL2 THRESHOLD
    
```

```

SET DISTANCE 20mA

0500 mm
    
```

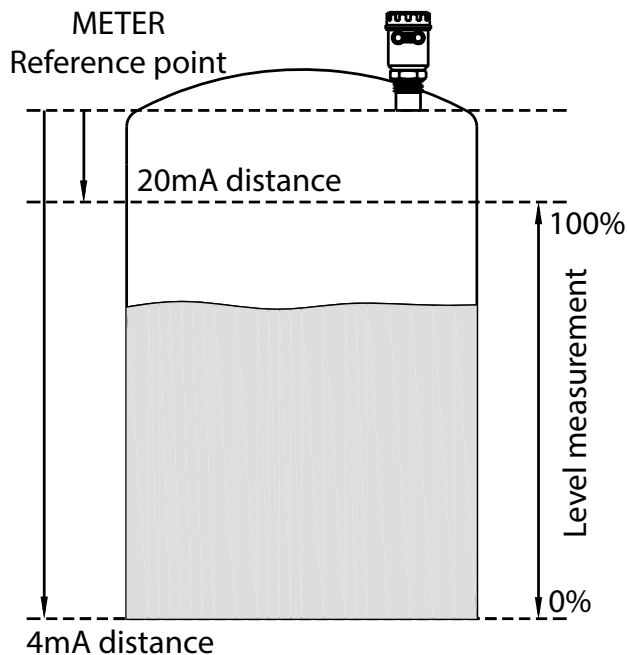

8.2.3 MEDIUM

Press ENTER to display the previous setting

Press SCROLL to select the medium type.
Press ENTER to confirm.

SET DISTANCE 4mA SET DISTANCE 20mA ► MEDIUM FILTER COEFFICIENT BLIND DISTANCE DISPLAY RL1 THRESHOLD RL2 THRESHOLD
--

MEDIUM ► LIQUIDS SOLIDS LIQUIDS PIPE

LIQUIDS

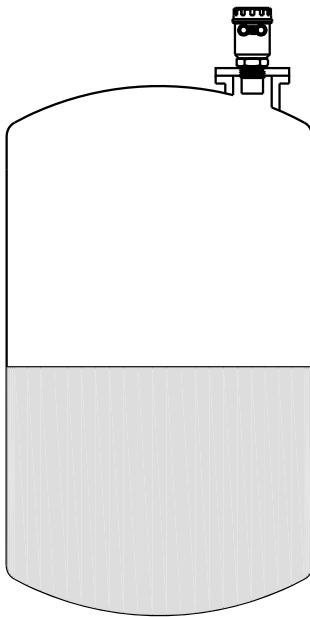

SOLIDS

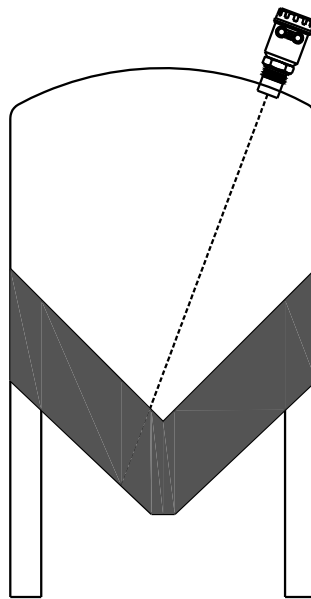

LIQUIDS PIPE

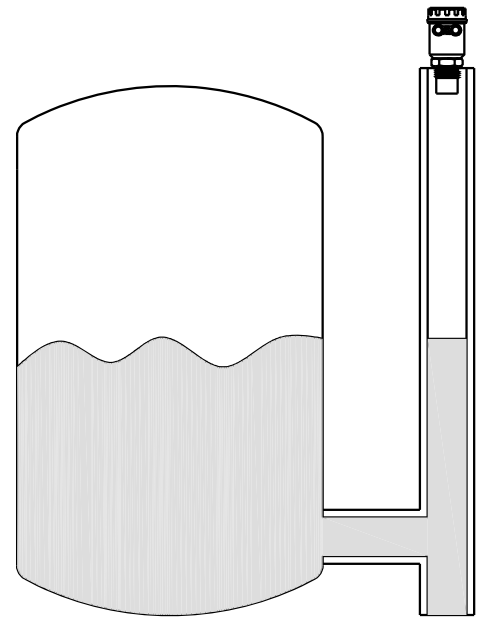

8.2.4 FILTER COEFFICIENT

Press ENTER.

Use SCROLL and UP ARROW to modify the value. Input a value from 1 to 99.

1 maximum speed, 99 maximum slowness.

The function is deactivated with 0 (immediate response).

Press ENTER to confirm

SET DISTANCE 4mA SET DISTANCE 20mA MEDIUM ► FILTER COEFFICIENT BLIND DISTANCE DISPLAY RL1 THRESHOLD RL2 THRESHOLD
--

FILTER COEFFICIENT

20

Fast resp. 5÷10

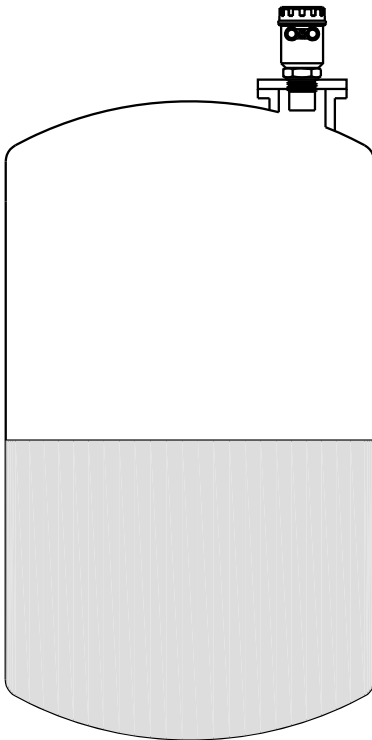

Normal resp. 20

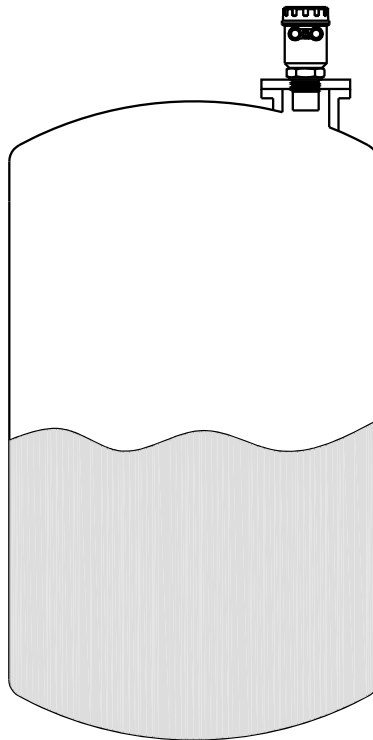

Slow resp. 40÷100

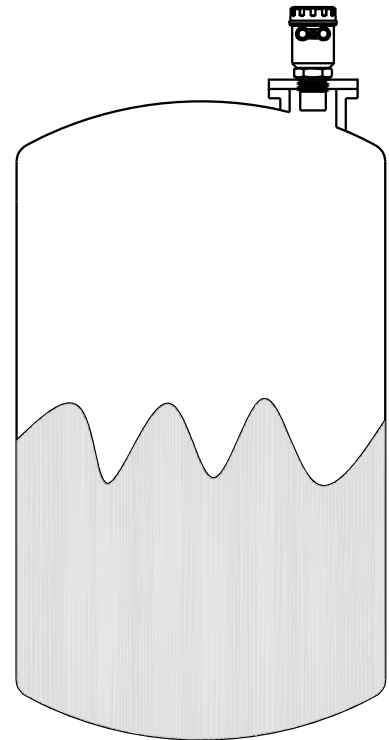

8.2.5 BLIND DISTANCE

Press ENTER.
The BLIND ZONE is used to avoid undesired measures near to the transmitter.

Use SCROLL and UP ARROW to modify the value. Press ENTER to confirm.
The minimum value is 250mm (6m max vers.) or 400mm (10m max vers.).

SET DISTANCE 4mA
SET DISTANCE 20mA
MEDIUM
FILTER COEFFICIENT
▶ BLIND DISTANCE
DISPLAY
RL1 THRESHOLD
RL2 THRESHOLD

BLIND DISTANCE
0250 mm

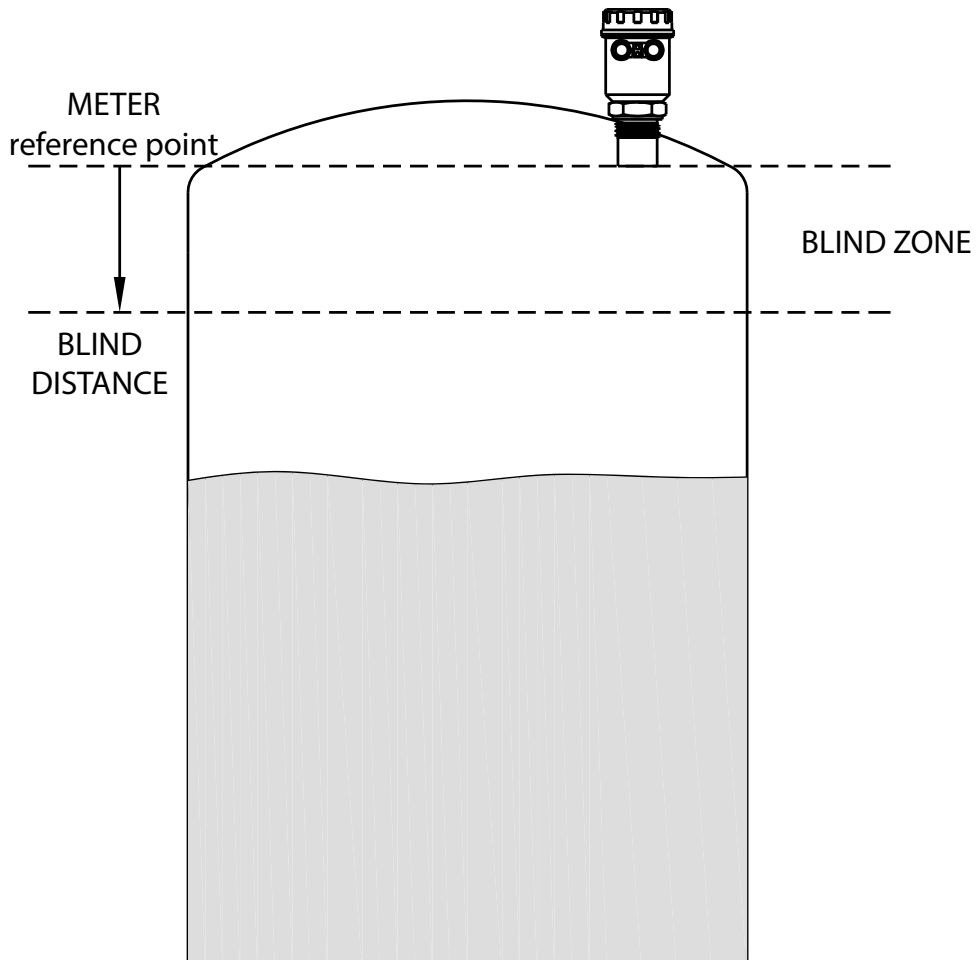

8.2.6 DISPLAY

Press ENTER to access the settings change.

With the SCROLL button is possible to select the data to display
Press ENTER to confirm.

SET DISTANCE 4mA
SET DISTANCE 20mA
MEDIUM
FILTER COEFFICIENT
BLIND DISTANCE
▶ DISPLAY
RL1 THRESHOLD
RL2 THRESHOLD

▶ DISTANCE mm
LEVEL mm
LEVEL %
OUTPUT mA
TEMP. °C

8.2.7 RL1 THRESHOLD

Press ENTER to display the previous setting. Set the distance from the sensor

Use SCROLL and UP ARROW to modify the value; in the example the RL1 max. level threshold distance is 700mm. Press ENTER to confirm.

NB - RL1 inactive with 0000mm

SET DISTANCE 4mA SET DISTANCE 20mA MEDIUM FILTER COEFFICIENT BLIND DISTANCE DISPLAY ► RL1 THRESHOLD RL2 THRESHOLD
--

RL1 THRESHOLD 0700 mm

When confirming with the ENTER button the maximum level threshold value storage, in the example 700m, the METER activates RL1 with the following default settings for level alarm threshold:

- 1) MIN / MAX = MAX; maximum level alarm
- 2) DELAY = 0 sec.; no switching delay
- 3) SECURITY = YES; relay de-energized, and contact open, during the maximum level alarm
- 4) ENABLE / DISABLE = ENABLE; alarm threshold function enabled
- 5) MIN/MAX HYSTERESIS mm = 40mm

To change these relay settings is necessary to access the advanced setup menu and any subsequent changes to the RL1 threshold value not affect the relay custom settings..

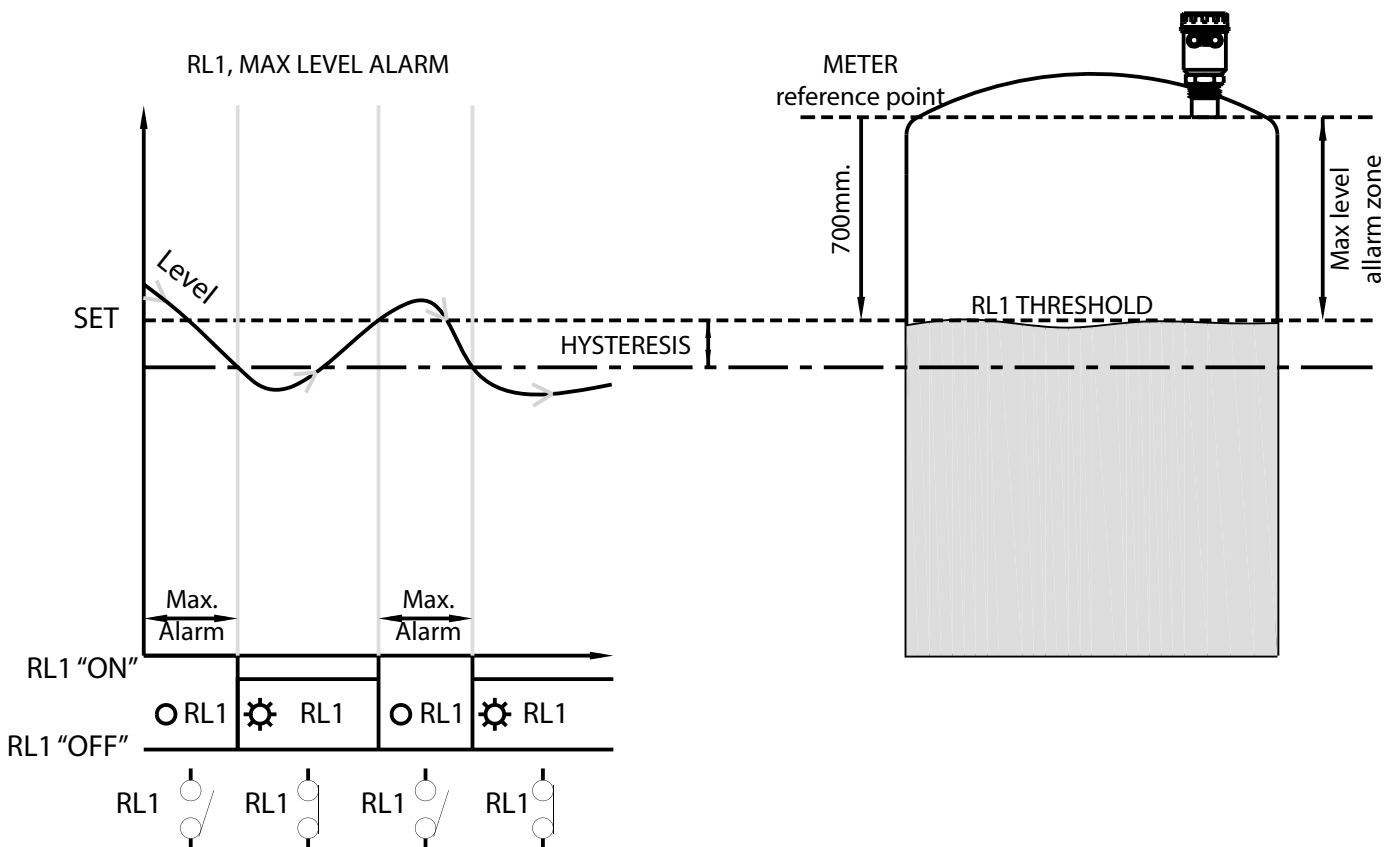

8.2.8 RL2 THRESHOLD

Press ENTER to display the previous setting. Set the distance from the sensor

Use SCROLL and UP ARROW to modify the value; in the example the RL2 min. level threshold distance is 3000mm. Press ENTER to confirm.

NB - RL2 inactive with 0000mm

SET DISTANCE 4mA SET DISTANCE 20mA MEDIUM FILTER COEFFICIENT BLIND DISTANCE DISPLAY RL1 THRESHOLD ► RL2 THRESHOLD
RL2 THRESHOLD 3000 mm

When confirming with the ENTER button the maximum level threshold value storage, in the example 3000mm the METER activates RL2 with the following default settings for level alarm threshold:

- 1) MIN / MAX = MIN; minimum level alarm
- 2) DELAY = 0 sec.; no switching delay
- 3) SECURITY = YES; relay de-energized, and contact open, during the maximum level alarm
- 4) ENABLE / DISABLE = ENABLE; alarm threshold function enabled
- 5) MIN/MAX HYSTERESIS mm = 40mm

To change these relay settings is necessary to access the advanced setup menu and any subsequent changes to the RL2 threshold value not affect the relay custom settings.

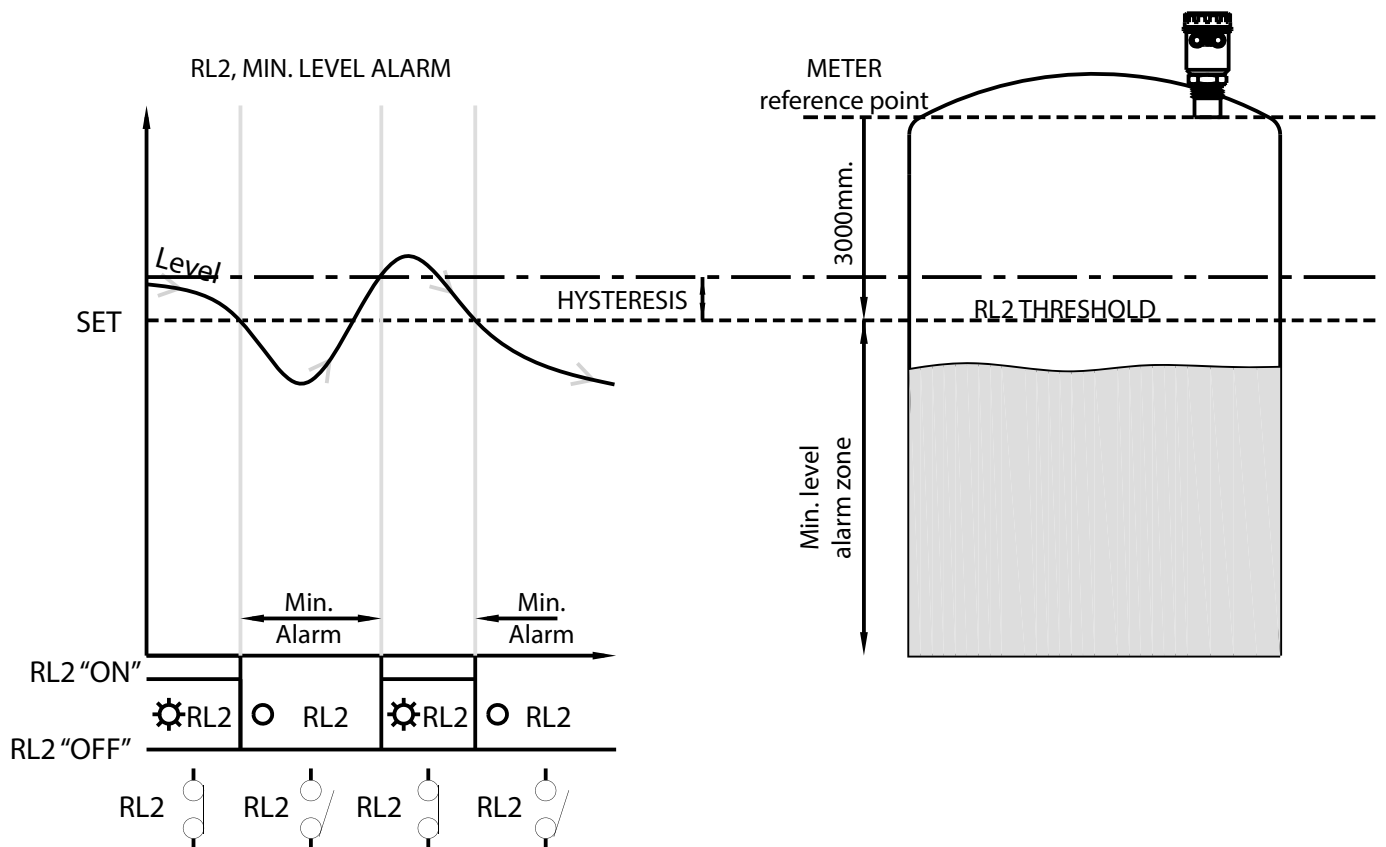

8.3 - ECHO MAP

Pressing LEFT ARROW, from RUN mode, to access directly to the echoes digital map display, which are in METER receiving.

This function is useful for:

- properly orient the transducer pointing.
- verify the echoes in acquisition correctness.
- identify any false echo signals that may cause measurement errors.

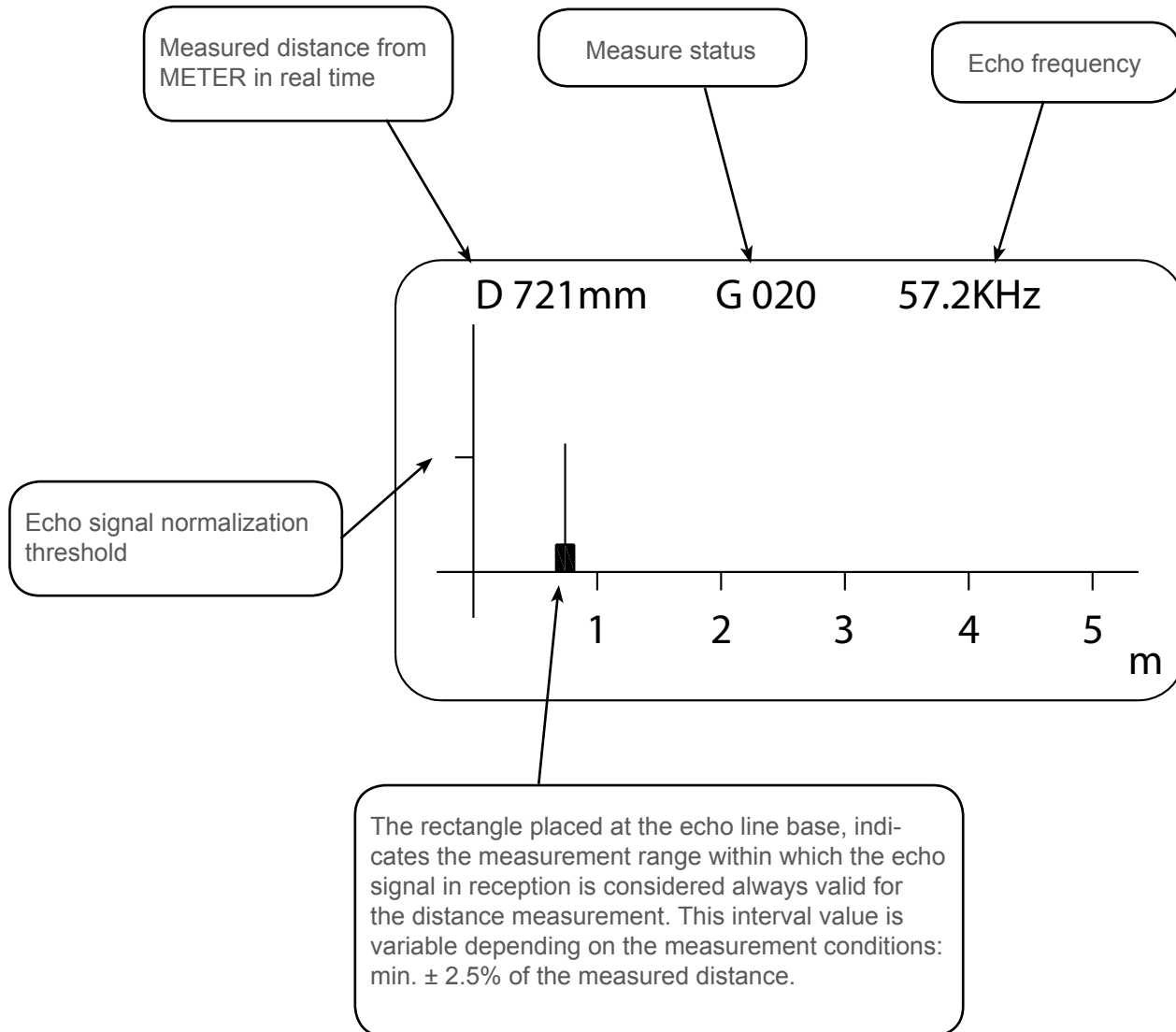

9-ADVANCED CONFIGURATION

9.1 - "SETUP" MENU

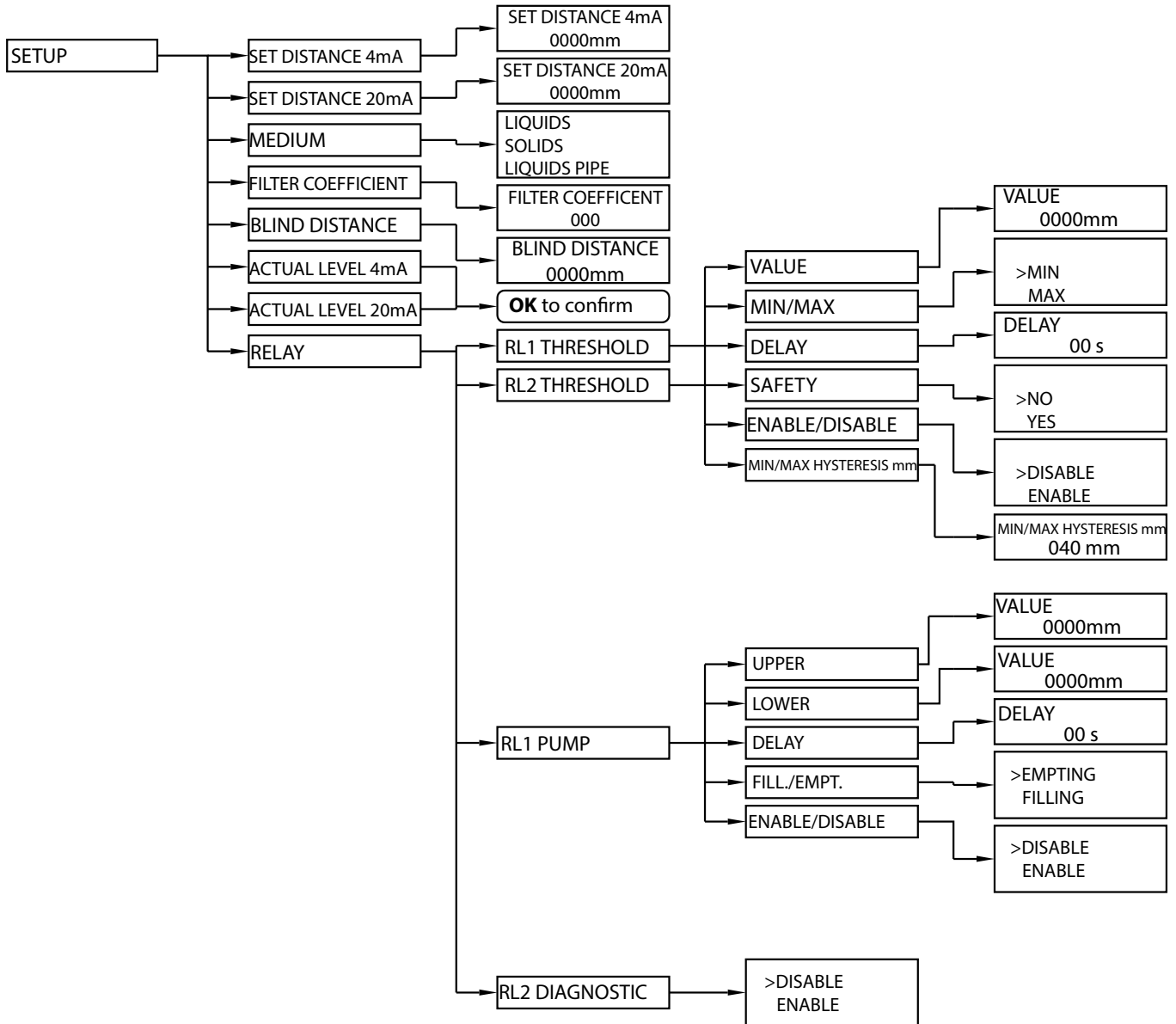

9.2 - SETUP

From "RUN" mode, holding down UP ARROW, press ENTER to the advanced configuration mode access.

Press SCROLL to select the menu and press ENTER to access. Press LEFT ARROW to exit.

4321^D mm

- ▶ SETUP
- DISPLAY
- DIAGNOSTIC
- SERVICE
- INFO

- ▶ SET DISTANCE 4mA
- SET DISTANCE 20mA
- MEDIUM
- FILTER COEFFICIENT
- BLIND DISTANCE
- ACTUAL LEV. 4mA
- ACTUAL LEV. 20mA
- RELAYS

9.2.1 - SET DISTANCE 4mA

Position the cursor on DISTANCE 4mA, press ENTER to access.

Use UP ARROW and SCROLL to modify the value.
 Press ENTER to confirm.
 LEFT ARROW to exit without changes

Default value: 6000mm (range 6m) or 10000mm (range 10m)

► SET DISTANCE 4mA
 SET DISTANCE 20mA
 MEDIUM
 FILTER COEFFICIENT
 BLIND DISTANCE
 ACTUAL LEV. 4mA
 ACTUAL LEV. 20mA
 RELAYS

SET DISTANCE 4mA
5000 mm

9.2.2 - SET DISTANCE 20mA

Position the cursor on DISTANCE 20mA, press ENTER to access.

Use UP ARROW and SCROLL to modify the value.
 Press ENTER to confirm.
 LEFT ARROW to exit without changes

Default value: 300mm (range 6m) or 500mm (range 10m)

SET DISTANCE 4mA
 ► SET DISTANCE 20mA
 MEDIUM
 FILTER COEFFICIENT
 BLIND DISTANCE
 ACTUAL LEV. 4mA
 ACTUAL LEV. 20mA
 RELAYS

SET DISTANCE 20mA
0300 mm

9.2.3 - MEDIUM

Position the cursor on MEDIUM, press ENTER to access.

3 configurations are possible:
 LIQUIDS - liquids measurement
 SOLIDS - granular solids measurement
 LIQUIDS PIPE - liquids measurement in pipe reference
 Press SCROLL to select the product type.
 Press ENTER to confirm.
 LEFT ARROW to exit without changes

Default value: LIQUIDS

SET DISTANCE 4mA
 SET DISTANCE 20mA
 ► MEDIUM
 FILTER COEFFICIENT
 BLIND DISTANCE
 ACTUAL LEV. 4mA
 ACTUAL LEV. 20mA
 RELAYS

MEDIUM
 ► LIQUIDS
 SOLIDS
 LIQUIDS PIPE

9.2.4 - FILTER COEFFICIENT

Position the cursor on FILTER COEFFICIENT, press ENTER to access.

Enter a value from 1 to 99: 1 maximum speed, 99 maximum slowness.
 The function is deactivated with 0 (immediate response)
 Use UP ARROW and SCROLL to modify the value.
 Press ENTER to confirm.
 LEFT ARROW to exit without changes

Default value: 20

SET DISTANCE 4mA
 SET DISTANCE 20mA
 MEDIUM
 ► FILTER COEFFICIENT
 BLIND DISTANCE
 ACTUAL LEV. 4mA
 ACTUAL LEV. 20mA
 RELAYS

FILTER COEFFICIENT
20

9.2.5 - BLIND DISTANCE

Position the cursor on DISTANCE 4mA, press ENTER to access.
Represent the "BLIND ZONE"

Input the desired value in order to avoid measures near the surface of the sensor (if necessary).

The minimum value is 250mm (6m vers.) or 400mm (10m vers.)

Use UP ARROW and SCROLL to modify the value.

Press ENTER to confirm.

LEFT ARROW to exit without changes

Default values: 250mm (range 6m) or 400mm (range 10m)

```

SET DISTANCE 4mA
SET DISTANCE 20mA
MEDIUM
FILTER COEFFICIENT
▶ BLIND DISTANCE
ACTUAL LEV. 4mA
ACTUAL LEV. 20mA
RELAYS

```

BLIND DISTANCE

0250 mm

9.2.6 - ACTUAL LEV. 4mA

Position the cursor on ACTUAL LEV. 4mA, press ENTER to access.

Self distance learning function that is associated with the 4mA (lower value). Make sure that the level corresponds to 0%, ENTER to associate the actual measure with 4mA output value;

OK TO CONFIRM .

LEFT ARROW to exit without changes.

```

SET DISTANCE 4mA
SET DISTANCE 20mA
MEDIUM
FILTER COEFFICIENT
BLIND DISTANCE
▶ ACTUAL LEV. 4mA
ACTUAL LEV. 20mA
RELAYS

```

9.2.7 - ACTUAL LEV. 20mA

Position the cursor on ACTUAL LEV. 20mA, press ENTER to access.

Self distance learning function that is associated with the 20mA (upper value). Make sure that the level corresponds to 100%, ENTER to associate the actual measure with 20mA output value;

OK TO CONFIRM .

LEFT ARROW to exit without changes.

```

SET DISTANCE 4mA
SET DISTANCE 20mA
MEDIUM
FILTER COEFFICIENT
BLIND DISTANCE
ACTUAL LEV. 4mA
▶ ACTUAL LEV. 20mA
RELAYS

```

9.2.8 - RELAYS

Position the cursor on RELAYS, press ENTER to access.

```

SET DISTANCE 4mA
SET DISTANCE 20mA
MEDIUM
FILTER COEFFICIENT
BLIND DISTANCE
ACTUAL LEV. 4mA
ACTUAL LEV. 20mA
▶ RELAYS
    
```

In this sub-menù it's possible to setup onboard relays (only 4-wires versions)

RL1 can be set as threshold relay or pump-control relay;

RL2 can be set as threshold relay or diagnostic relay.

With the SCROLL button you can select the operation mode, then pressing ENTER to confirm the selection

```

▶ RL1 THRESHOLD
RL2 THRESHOLD
RL1 PUMP
RL2 DIAGNOSTIC
    
```

9.2.8.1 - RL1 THRESHOLD (RL2 THRESHOLD equivalent)

Position the cursor on RL1 THRESHOLD, press ENTER to access.

```

▶ RL1 THRESHOLD
RL2 THRESHOLD
RL1 PUMP
RL2 DIAGNOSTIC
    
```

In this submenu you can set the set-point and the relay 1 and 2 action type (only 4-wires versions).

With the SCROLL button you can select the parameter to be programmed.

Press ENTER to confirm

```

▶ VALUE
MIN/MAX
DELAY
SAFETY
ANABLE/DISABLE
MIN/MAX HYSTERESIS
    
```

9.2.8.1.1 - VALUE

Position the cursor on VALUE, press ENTER to access.

```

▶ VALUE
MIN/MAX
DELAY
SAFETY
ANABLE/DISABLE
MIN/MAX HYSTERESIS
    
```

It's possible to input the threshold value that corresponds to the distance in mm from the sensor.

Use UP ARROW and SCROLL to modify the value.

Press ENTER to confirm.

LEFT ARROW to exit without changes

Default value: 0000mm

NB-RL1/2 inactive with 0000mm

```

VALUE
1000 mm
    
```

9.2.8.1.2 - MIN/MAX

Position the cursor on VALUE, press ENTER to access.

```

VALUE
▶ MIN/MAX
DELAY
SAFETY
ANABLE/DISABLE
MIN/MAX HYSTERESIS
    
```

It's possible to select if the relay works as maximum level threshold or minimum level threshold.

With the SCROLL button you can select the operation mode.

Press ENTER to confirm.

LEFT ARROW to exit without changes

Default value: MAX for RL1; MIN for RL2

```

MIN
▶ MAX
    
```

9.2.8.1.3 - DELAY

Position the cursor on DELAY, press ENTER to access.

It's possible to set the activation delay for the selected relay, from 0 to 99 sec.

Use UP ARROW and SCROLL to modify the value.

Press ENTER to confirm.

LEFT ARROW to exit without changes

Default value: 00s

```

VALUE
MIN/MAX
▶ DELAY
SAFETY
ANABLE/DISABLE
MIN/MAX HYSTERESIS

```

```

DELAY

00 s

```

9.2.8.1.4 - SAFETY

Position the cursor on SAFETY, press ENTER to access.

A "safety alarm" provides a "closed" contact with relay energized in normal condition (no alarm), the contact switches to "open":

- Alarm condition (eg overcoming MAX);

- In power failure case.

With the SCROLL button you can select the alarm mode.,

Press ENTER to confirm.

LEFT ARROW to exit without changes

Default value: YES

```

VALUE
MIN/MAX
DELAY
▶ SAFETY
ANABLE/DISABLE
MIN/MAX HYSTERESIS

```

```

NO
▶ YES

```

9.2.8.1.5 - ENABLE/DISABLE

Position the cursor on ENABLE/DISABLE, press ENTER to access.

Select ENABLE to activate relay threshold.

Select DISABLE to not activate relay threshold.

With the SCROLL button you can select the operation mode.

Press ENTER to confirm.

LEFT ARROW to exit without changes

Default value: DISABLE

```

VALUE
MIN/MAX
DELAY
SAFETY
▶ ANABLE/DISABLE
MIN/MAX HYSTERESIS

```

```

DISABLE
▶ ENABLE

```

9.2.8.1.6 - MIN/MAX HYSTERESIS mm

Position the cursor on MIN/MAX HYSTERESIS mm, press ENTER to access.

It's possible to input the threshold hysteresis.

Use UP ARROW and SCROLL to modify the value.

Press ENTER to confirm.

LEFT ARROW to exit without changes

Default value: 40mm

```

VALUE
MIN/MAX
DELAY
SAFETY
ANABLE/DISABLE
▶ MIN/MAX HYSTERESIS

```

```

MIN/MAX HYSTERESIS mm

040 mm

```

9.2.8.2 - RL1 PUMP (only for RL1)

Position the cursor on RL1 PUMP, press ENTER to access

A pump control functioning activation, with hysteresis, is possible two thresholds setting is required: upper and lower threshold.

With the SCROLL button you can select the parameter to be programmed, Press ENTER to confirm.

9.2.8.2.1 - UPPER

Position the cursor on UPPER, press ENTER to access.

The upper threshold is expressed in mm distance from the sensor. Represents the pump starting point, EMPTY case, or pump stopping point, FILLING case.

Use UP ARROW and SCROLL to modify the value.

Press ENTER to confirm.

LEFT ARROW to exit without changes

Default value: 0

9.2.8.2.2 - LOWER

Position the cursor on LOWER, press ENTER to access.

The lower threshold is expressed in mm distance from the sensor. Represents the pump stopping point, EMPTY case, or pump starting point, FILLING case.

Use UP ARROW and SCROLL to modify the value.

Press ENTER to confirm.

LEFT ARROW to exit without changes

Default value: 0

RL1 THRESHOLD
RL2 THRESHOLD
▶ RL1 PUMP
RL2 DIAGNOSTIC

▶ UPPER
LOWER
DELAY
FILL./EMPT.
ENABLE/DISABLE

▶ UPPER
LOWER
DELAY
FILL./EMPT.
ENABLE/DISABLE

VALUE
0900 mm

UPPER
▶ LOWER
DELAY
FILL./EMPT.
ENABLE/DISABLE

VALUE
4000 mm

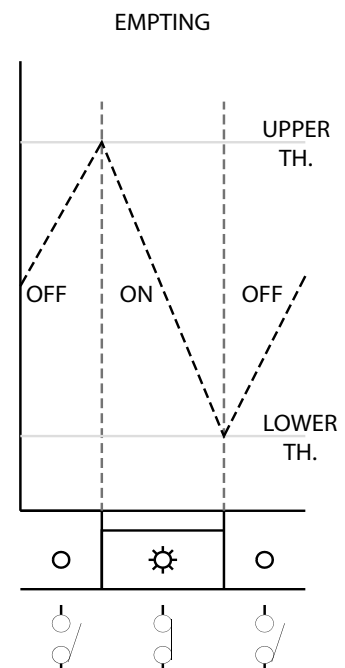
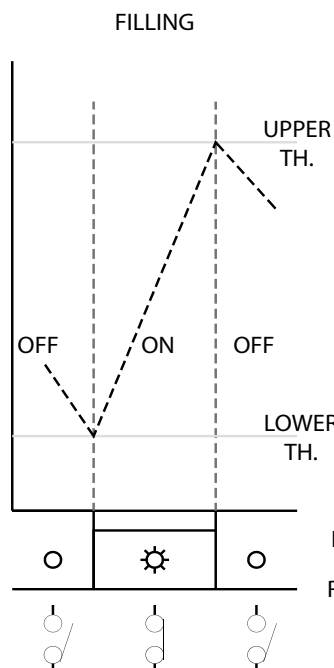
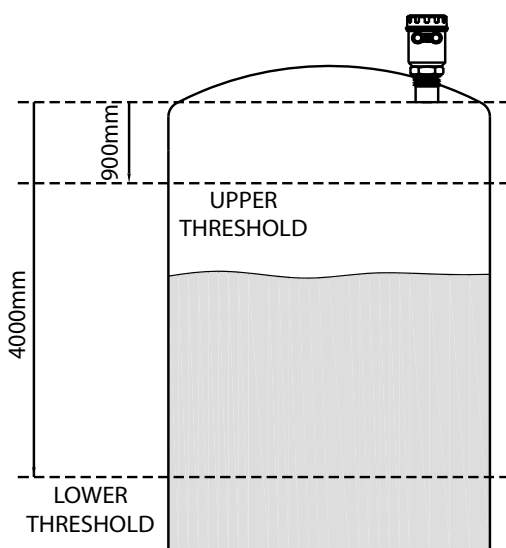

RL1 ON
RL1 OFF

9.2.8.2.3 - DELAY

Position the cursor on DELAY, press ENTER to access.

Set the relay delay activation, from 0 to 99 sec.
 Use UP ARROW and SCROLL to modify the value.
 Press ENTER to confirm.
 LEFT ARROW to exit without changes

Default value: 0

9.2.8.2.4 - FILL./EMPT

Position the cursor on DELAY, press ENTER to access.

it's possible to select the mode of pump control (FILLING or EMPTING)
 With the SCROLL button you can select the operation mode.
 Press ENTER to confirm.
 LEFT ARROW to exit without changes

Default value: EMPTING

9.2.8.2.5 - ENABLE/DISABLE

Position the cursor on ENABLE/DISABLE, press ENTER to access.

Select ENABLE to activate relay threshold.
 Select DISABLE to not activate relay threshold.
 With the SCROLL button you can select the operation mode.
 Press ENTER to confirm.
 LEFT ARROW to exit without changes

Default value: DISABLE

9.2.8.3 - RL2 DIAGNOSTIC

Position the cursor on RL2 DIAGNOSTIC, press ENTER to access.

If it becomes necessary the METER functional control, it's possible to enable the RL2 alarm output function. In this case, enabling the function, RL2 is energized in normal operation (RL2 LED on) and is de-energized (LED RL2 off, safety alarm) when at least one of the four conditions mentioned below, shall be verified:

- TEMP. : temperature out of range
- ECHO : no echo is detected
- GAIN : the sensor's gain exceed the value setted in Max Gain TH (7.3.5)
- DIST. : the measured distance exceed the 120% of the maximum distance in setup

Select ENABLE to activate relay threshold.
 Select DISABLE to not activate relay threshold.
 With the SCROLL button you can select the operation mode.
 Press ENTER to confirm.
 LEFT ARROW to exit without changes
 Default value: DISABLE

when an error occurs, a "!" is flashing on the display: press SCROLL to show a message that indicate what kind of error is present. The METER automatically returns to RUN mode.

UPPER LOWER ► DELAY FILL./EMPT. ENABLE/DISABLE
DELAY 05 s
UPPER LOWER DELAY ► FILL./EMPT. ENABLE/DISABLE
► EMPTING FILLING
UPPER LOWER DELAY FILL./EMPT. ► ENABLE/DISABLE
► DISABLE ENABLE
RL1 THRESHOLD RL2 THRESHOLD RL1 PUMP ► RL2 DIAGNOSTIC
► DISABLE ENABLE

9.3 “DISPLAY” menu

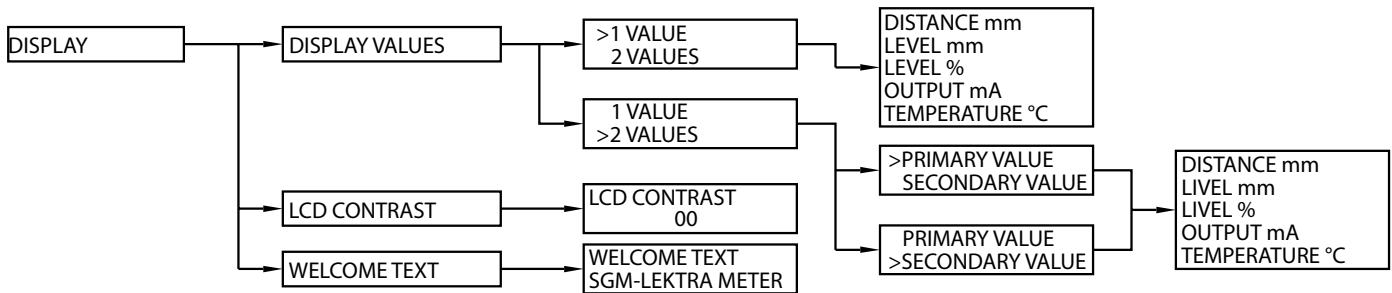

9.4 - DISPLAY

From “RUN” mode, holding down UP ARROW, press ENTER to access
Position the cursor on DISPLAY and press ENTER

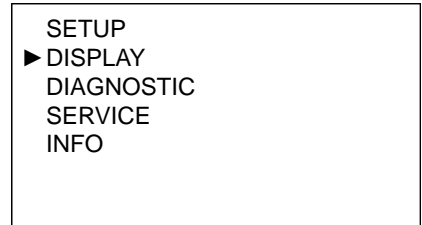

Select the parameters by moving the cursor with SCROLL and confirm with ENTER

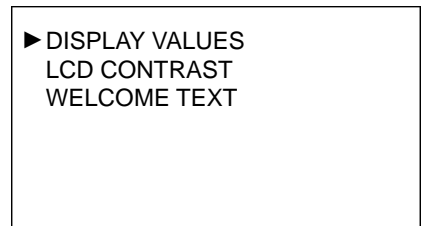

9.4.1 - DISPLAY VALUES

Position the cursor on DISPLAY VALUES, press ENTER to access.

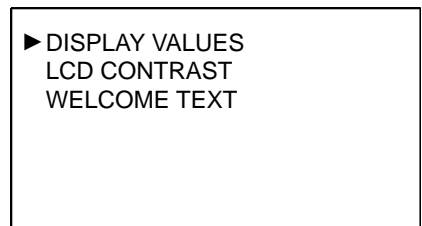

It's possible to select if one value with big digits or two values are shown on the display in “RUN” mode.
Select the parameters by moving the cursor with SCROLL and confirm with ENTER.
LEFT ARROW to exit without changes



9.4.1.1 - 1 VALUE

Position the cursor on 1 VALUE, press ENTER to access.

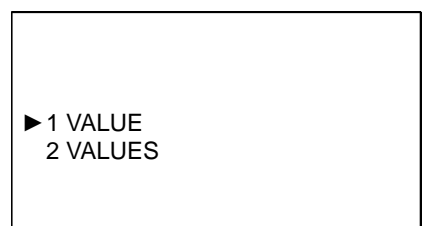

Only one value is displayed; it's possible to choose from 5 parameters.
With the SCROLL button you can select data to display.
Press ENTER to confirm.
LEFT ARROW to exit without changes

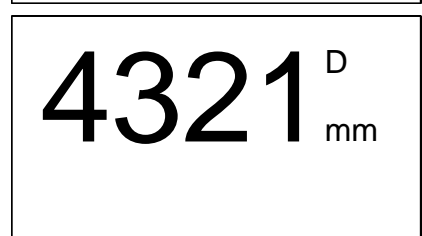
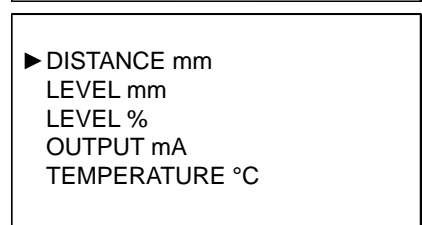

9.4.1.2 - 2 VALUE

Position the cursor on 2 VALUE, press ENTER to access.

Two values are displayed; it's possible to choose which one is the primary and which is the secondary, each with a choice of 5 parameters. With the SCROLL button you can select data to display. Press ENTER to confirm. LEFT ARROW to exit without changes

1 VALUE
▶ 2 VALUES

▶ PRIMARY VALUE
SECONDARY VALUE

▶ DISTANCE mm
LEVEL mm
LEVEL %
OUTPUT mA
TEMPERATURE °C

PRIMARY VALUE
▶ SECONDARY VALUE

DISTANCE mm
▶ LEVEL mm
LEVEL %
OUTPUT mA
TEMPERATURE °C

9.4.2 - LCD CONTRAST

Position the cursor on LCD CONTRAST, press ENTER to access.

it's possible to adjust the contrast of LCD, simply increasing or decreasing the value of a parameter from 0 to 63. Use UP ARROW and SCROLL to modify the value. Press ENTER to confirm. LEFT ARROW to exit without changes

Default value: 32

DISPLAY VALUES
▶ LCD CONTRAST
WELCOME TEXT

LCD CONTRAST

32

9.4.3 - WELCOME TEXT

Position the cursor on WELCOME TEXT, press ENTER to access.

It's possible to edit or delete the message that is displayed by the METER during the ignition phase.

Use UP ARROW (up scroll) and SCROLL (down scroll) to change the digit; ENTER to move the digit to the right. To confirm press ENTER repeatedly until leave the parameter.

LEFT ARROW to exit without changes

Default value: SGM-LEKTRA METER

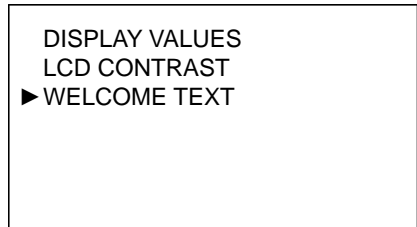

9.5 “DIAGNOSTIC” menu

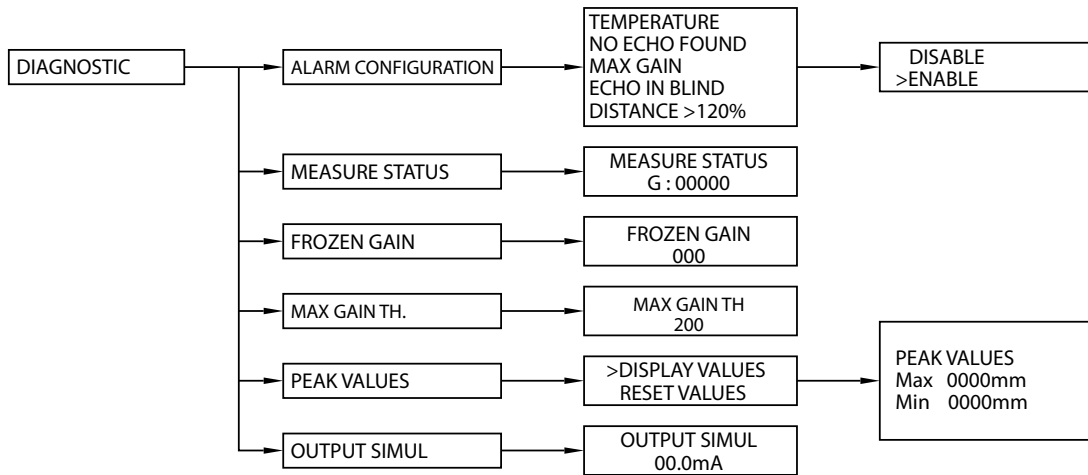

9.6 - DIAGNOSTIC

From “RUN” mode, holding down UP ARROW, press ENTER to access
Position the cursor on DIAGNOSTIC and press ENTER

```

    SETUP
    DISPLAY
    ► DIAGNOSTIC
    SERVICE
    INFO
  
```

Select the parameters by moving the cursor with SCROLL and confirm with ENTER

```

    ► ALARM CONFIGURATION
    MEASURE STATUS
    FROZEN GAIN
    MAX GAIN TH.
    PEAK VALUES
    OUTPUT SIMUL.
  
```

9.6.1 - ALARM CONFIGURATION

Position the cursor on ALARM CONFIGURATION, press ENTER to access

To enable or disable each diagnostic alarms.

```

    ► ALARM CONFIGURATION
    MEASURE STATUS
    FROZEN GAIN
    MAX GAIN TH.
    PEAK VALUES
    OUTPUT SIMUL.
  
```

- with UP ARROW or SCROLL chose the desired item and press ENTER

```

    ► TEMPERATURE
    NO ECHO FOUND
    MAX GAIN
    ECHO IN BLIND
    DISTANCE >120%
  
```

- with UP ARROW or SCROLL enable or disable the alarm signal and press ENTER to confirm

```

    DISABLE
    ► ENABLE
  
```

9.6.2 - MEASURE STATUS

Position the cursor on MEASURE STATUS, press ENTER to access.

It's possible to display the gain of the system, with values from 0 to 255. LEFT ARROW to exit

```
ALARM CONFIGURATION
▶ MEASURE STATUS
  FROZEN GAIN
  MAX GAIN TH.
  PEAK VALUES
  OUTPUT SIMUL.
```

```
MEASURE STATUS

G: 00000
```

9.6.3 - FROZEN GAIN

Position the cursor on MEASURE STATUS, press ENTER to access.

It's possible to fix a value of gain (from 1 to 255) and consequently disable the automatic gain control. Once the value is 000 the automatic gain control restarts.

Use UP ARROW and SCROLL to modify the value.

Press ENTER to confirm.

LEFT ARROW to exit without changes

Default value: 000

```
ALARM CONFIGURATION
MEASURE STATUS
▶ FROZEN GAIN
  MAX GAIN TH.
  PEAK VALUES
  OUTPUT SIMUL.
```

```
FROZEN GAIN

000
```

9.6.4 - MAX GAIN TH

Position the cursor on MAX GAIN TH, press ENTER to access.

It's possible to change the max value of gain. If the gain reaches this value, the "GAIN" error code is activated

Use UP ARROW and SCROLL to modify the value.

Press ENTER to confirm.

LEFT ARROW to exit without changes

Default value: 200

```
ALARM CONFIGURATION
MEASURE STATUS
FROZEN GAIN
▶ MAX GAIN TH.
  PEAK VALUES
  OUTPUT SIMUL.
```

```
MAX GAIN TH

200
```

9.6.5 - PEAK VALUES

Position the cursor on PEAK VALUES, press ENTER to access.

The system store the maximum distance and the minimum distance measured since the power is turned ON.

It's possible to see those values or reset the values.

With the SCROLL button you can select the function.

Press ENTER to confirm.

```
ALARM CONFIGURATION
MEASURE STATUS
FROZEN GAIN
MAX GAIN TH.
▶ PEAK VALUES
  OUTPUT SIMUL.
```

```
▶ DISPLAY VALUES

RESET VALUES
```

9.6.5.1 - DISPLAY VALUES

Position the cursor on DISPLAY VALUES, press ENTER to access.

Displays the max. and min. distance measured from power on.
LEFT ARROW to exit.

NB - The peak values stored are erased every time the METER turns-off

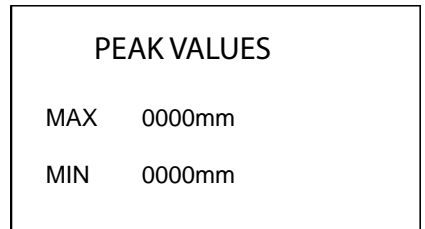

9.6.5.2 - RESET VALUES

Position the cursor on RESET VALUES, press ENTER to access.

LEFT ARROW to return to the previous menu



9.6.6 - OUTPUT SIMULATION

WARNING - entering in the SIMULATION function, the current output is not in function of the level measurement. To restore the current as a measured level function, press the LEFT ARROW button 3 times (RUN mode)

Position the cursor on OUTPUT SIMULATION, press ENTER to access.

It's possible to force the analog output to a desired value, from 3,5 to 21mA.

Use UP ARROW and SCROLL to modify the value.

LEFT ARROW to return to the previous menu.

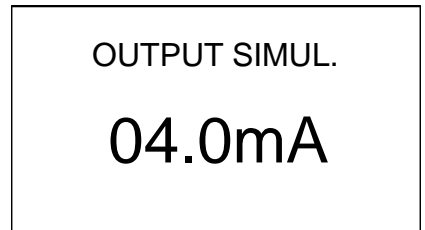
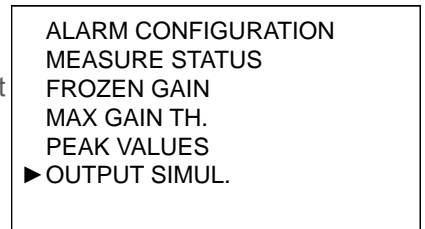

9.7 "SERVICE" menu

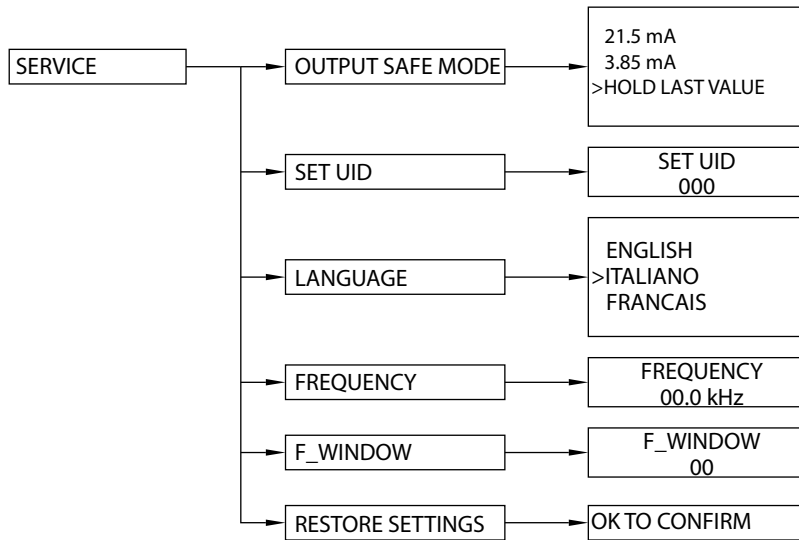

9.8 - SERVICE

From "RUN" mode, holding down UP ARROW, press ENTER to access Position the cursor on SERVICE and press ENTER

```

    SETUP
    DISPLAY
    DIAGNOSTIC
    ► SERVICE
    INFO
  
```

Select the parameters by moving the cursor with SCROLL and confirm with ENTER

```

    ► OUTPUT SAFE MODE
    SET UID
    LANGUAGE
    FREQUENCY
    F_WINDOW
    RESTORE SETTING
  
```

9.8.1 - OUTPUT SAFE MODE

Position the cursor on OUTPUT SAFE MODE, press ENTER to access.

It's possible to choose a analog output value during diagnostic errors.
 "21.5 mA" forces the current output to 21,5mA
 "3.85 mA" forces the current output to 3,85mA
 "HOLD LAST VALUE" maintains the output at the last valid value.
 With the SCROLL button you can select the operation mode.
 Press ENTER to confirm.
 LEFT ARROW to exit without changes

Default value: HOLD LAST VALUE

```

    ► OUTPUT SAFE MODE
    SET UID
    LANGUAGE
    FREQUENCY
    F_WINDOW
    RESTORE SETTING
  
```

```

    ► 21.5 mA
    3.85 mA
    HOLD LAST VALUE
  
```

9.8.2 - SET UID

Position the cursor on SET UID, press ENTER to access.

Can assign the address UID in this parameter, for a MUDBUS RTU network.

Use UP ARROW and SCROLL to modify the value.
 Press ENTER to confirm.
 LEFT ARROW to exit without changes

Default value 001

```

    OUTPUT SAFE MODE
    ► SET UID
    LANGUAGE
    FREQUENCY
    F_WINDOW
    RESTORE SETTING
  
```

```

    SET UID
    001
  
```

9.8.3 - LANGUAGE

Position the cursor on LANGUAGE, press ENTER to access.

Sets the menu language: English, Italian, French

Press SCROLL to select the menu language.

Press ENTER to confirm.

LEFT ARROW to exit without changes

```

OUTPUT SAFE MODE
SET UID
▶ LANGUAGE
FREQUENCY
F_WINDOW
RESTORE SETTING
    
```

```

ENGLISH
▶ ITALIANO
FRANCAIS
    
```

9.8.4 - FREQUENCY

Position the cursor on FREQUENCY, press ENTER to access.

It's possible to check the computed sensor emission frequency.

LEFT ARROW to exit without changes

```

OUTPUT SAFE MODE
SET UID
LANGUAGE
▶ FREQUENCY
F_WINDOW
RESTORE SETTING
    
```

```

          FREQUENCY
          00.0 kHz
    
```

9.8.5 - F_WINDOW

Position the cursor on F_WINDOW, press ENTER to access.

It is the increase value (in cm), step to step, of the window width during the echo signal research phase.

The "F_WINDOW" is the area where the echo reception is active.

Normally it is positioned around the real echo signal and all echoes detected within the F_WINDOW are deemed valid.

Example: F_WINDOW parameter set to 5.

- The METER detects an echo signal which is 4 meters from the sensor.

- Suddenly, the echo signal disappears and a new echo signal to 3.5 mt away from the sensor is detected.

- Each time the echo signal will be emitted, the METER will enlarge "F_WINDOW" with 5cm step, until covering the new eco detected area.

Now the F_WINDOW will start to tighten around the new echo signal and the new measurement of 3,5mt distance will be used to calculate the level measurement, alarm thresholds, etc..

F_WINDOW serves to filter false echo signals products, for example, by the agitator blades

Range: 05÷20

Use UP ARROW and SCROLL to modify the value.

Press ENTER to confirm.

LEFT ARROW to exit without changes

Default value: 05 (2 wires versions) e 10 (4 wires versions)

```

OUTPUT SAFE MODE
SET UID
LANGUAGE
FREQUENCY
▶ F_WINDOW
RESTORE SETTING
    
```

```

          SET WIDTH
          05
    
```

9.8.6 - RESTORE SETTING

Position the cursor on SET UID, press ENTER to access.

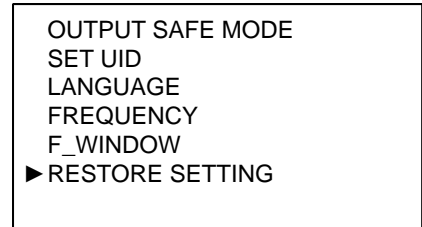

Press ENTER to restore the METER default settings
LEFT ARROW to exit without restored the METER default settings



9.8.7 "INFO" menu

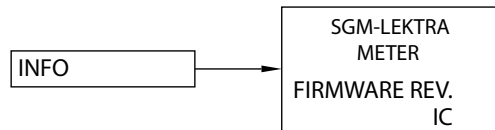

9.8.8 - INFO

Position the cursor on INFO, press ENTER to access.

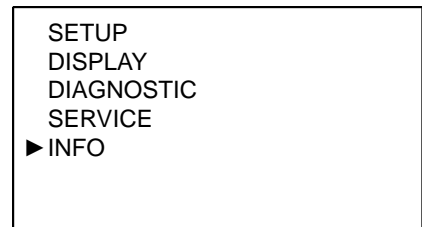

In addition to information about the manufacturer, are displayed the firmware revision and the configuration index

